



National Report of Hungary

on the Targeted Safety Re-assessment of Paks Nuclear Power Plant



Compiled for the European Commission
by the Hungarian Atomic Energy Authority

Hungarian Atomic Energy Authority
Budapest, December 29, 2011

	Name, assignment	Signature	Date
Editor:	Dr. Ferenc Adorján HAEA Chief Advisor		29/12/2011
Verified by:	Gyula Fichtinger DDG of HAEA		29/12/2011
Approved by:	Dr. József Rónaky DG of HAEA		29/12/2011

Contents

0. GENERAL REQUIREMENTS AND CONDITIONS OF THE ASSESSMENT	6
0.1. Initiative	6
0.2. Structure of the report.....	7
0.3. Role of the authority in the review	7
0.4. Legal and regulatory requirements	8
1. GENERAL DATA ABOUT THE SITE AND NUCLEAR POWER PLANT.....	9
1.1. Brief description of the site characteristics	9
1.1.1. Main characteristics of the units	10
1.1.2. Description of the systems for conduction of main safety functions.....	12
1.2. Significant differences between units	25
1.2.1. Differences between the Emergency diesel generators.....	25
1.2.2. Status of severe accident management modifications	26
1.2.3. Location of demineralised water storage tanks of Installation II	26
1.2.4. Recovery of essential service water system after emptying	27
1.2.5. Delivery of fire water into essential service water system.....	27
1.3. Use of PSA as part of the safety assessment	27
1.3.1. Scope of probabilistic safety assessments.....	27
1.3.2. Results of the re-assessment.....	27
2. EARTHQUAKES.....	33
2.1. Design basis	33
2.1.1. Earthquake against which the plant is designed	33
2.1.2. Provisions to protect the plants against the design basis earthquake	37
2.1.3. Compliance of the plant with its current licensing basis	42
2.2. Evaluation of safety margins.....	43
2.2.1. Range of earthquakes leading to severe fuel damage	43
2.2.2. Range of earthquakes leading to loss of containment integrity.....	48
2.2.3. Earthquake exceeding the design basis earthquake for the plant and consequent flooding exceeding design basis flood.....	50
2.2.4. Measures which can be envisaged to increase robustness of the plants against earthquakes	50
3. FLOODING	52
3.1. Design basis	52
3.1.1. Flooding against which the plant is designed	52
3.1.2. Provisions to protect the plants against the design basis flood	54
3.1.3. Plant compliance with its current licensing basis	54
3.2. Evaluation of safety margins.....	54
3.2.1. Estimation of safety margin against flooding	54

3.2.2.	Measures which can be envisaged to increase robustness of the plants against flooding	55
4.	EXTREME WEATHER CONDITIONS	56
4.1.	Design basis	56
4.1.1.	Re-assessment of weather conditions used as design basis	57
4.2.	Evaluation of safety margins	58
4.2.1.	Estimation of safety margin against extreme weather conditions	58
4.2.2.	Measures which can be envisaged to increase robustness of the plants against extreme weather conditions	61
5.	LOSS OF ELECTRICAL POWER AND LOSS OF ULTIMATE HEAT SINK.....	62
5.1.	Loss of electric power	62
5.1.1.	Loss of off-site power	62
5.1.2.	Loss of off-site power and loss of the ordinary back-up AC power source	64
5.1.3.	Loss of off-site power and loss of the ordinary back-up AC power sources, and loss of permanently installed diverse back-up AC power sources	65
5.1.4.	Conclusion on the adequacy of protection against loss of electrical power	66
5.1.5.	Measures which can be envisaged to increase robustness of the plants in case of loss of electrical power	68
5.2.	Loss of decay heat removal capability/ultimate heat sink.....	68
5.2.1.	Design provisions to prevent the loss of the primary ultimate heat sink.....	69
5.2.2.	Loss of primary ultimate heat sink	71
5.2.3.	Loss of primary ultimate heat sink and alternative heat sink.....	74
5.2.4.	Conclusions on the adequacy of the protection against the loss of the ultimate heat sink.....	80
5.2.5.	Measures which can be envisaged to increase robustness of the plants in case of loss of ultimate heat sink	82
5.3.	Loss of the primary ultimate heat sink, combined with station blackout	84
5.3.1.	Time of autonomy of the site before loss of normal cooling condition of the reactor core and spent fuel pool	84
5.3.2.	External actions foreseen to prevent fuel degradation	84
5.3.3.	Measures, which can be envisaged to increase robustness of the plant in case of loss of primary ultimate heat sink, combined with station blackout.....	84
6.	SEVERE ACCIDENT MANAGEMENT.....	85
6.1.	Organization and arrangements of the licensee to manage accidents.....	85
6.1.1.	Organization of the licensee to manage the accident	85
6.1.2.	Possibility to use existing equipment	87
6.1.3.	Evaluation of factors that may impede accident management and respective contingencies	89
6.1.4.	Organizational issues for accident management.....	93
6.1.5.	Measures which can be envisaged to enhance accident management capabilities	94
6.2.	Accident management measures in place at the various stages of a scenario of loss of the core cooling function	94
6.2.1.	Measures before fuel damage in the reactor pressure vessel	95
6.2.2.	Measures after fuel damage in the reactor pressure vessel	95
6.2.3.	Measures after failure of the reactor pressure vessel.....	96

6.3. Maintaining the containment integrity	96
6.3.1. Elimination of fuel damage/meltdown on high pressure	96
6.3.2. Management of hydrogen risk inside the containment	96
6.3.3. Prevention of overpressure of the containment	97
6.3.4. Prevention of re-criticality	98
6.3.5. Prevention of basement melt through	98
6.3.6. Tools and resources used for protecting containment integrity	98
6.3.7. Measuring and control instrumentation needed for protecting containment integrity	99
6.3.8. Management of multi-unit severe accidents.....	99
6.3.9. Conclusion on the adequacy of severe accident management systems for protection of containment integrity	99
6.3.10. Measures which can be envisaged to enhance capability to maintain containment integrity after occurrence of severe fuel damage.....	100
6.4. Accident management measures to restrict the radioactive releases	100
6.4.1. Radioactive releases after loss of containment integrity	100
6.4.2. Accident management after uncovering of the top of fuel in the fuel pool.....	100
6.4.3. Conclusion on the adequacy of measures to restrict the radioactive releases	100
7. GENERAL CONCLUSION	102
7.1. Key provisions enhancing robustness (already implemented)	102
7.2. Safety issues, "cliff edge" effects	103
7.3. Potential safety improvements and further work forecasted.....	104
7.3.1. Measures envisaged to further increase of safety	104
7.3.2. Evaluation of safety after implementation of the proposed improvement measures.....	107
REFERENCES	108
ABBREVIATIONS	109

0. General requirements and conditions of the assessment

0.1. Initiative

On March 11, 2011 an extremely large tsunami that followed the largest earthquake in Japan's written history caused a severe accident in Fukushima Dai-ichi Nuclear Power Plant. The lessons of this accident have been evaluated basically in each country and by each utility operating nuclear power plants, in order to determine any possible improvement of the safety of the plants. The European Council in its meeting of March 25, 2011, decided to request the European Commission and its advisory body, the European Nuclear Safety Regulators Group (ENSREG) to elaborate the content and methodology of an integrated risk and safety review of the nuclear power plants in the European Union, to facilitate this process in a controlled manner. Based on the request the ENSREG, in agreement with the European Commission, published a Declaration [1] on May 13, 2011 regarding the implementation of a "stress test" of the European nuclear power plants. In Hungary the review process is officially renamed to Targeted Safety Re-Assessment (TSR). The re-assessment is going on in two parallel processes. The first one is addressing the nuclear safety issues, with special regard to the protection against external (first of all natural) effects; while the second one is aimed to review the protection against malevolent human acts (nuclear security). The two assessments take place independently of each other, and the ENSREG essentially deals only with the first one, since most of its member authorities do not have due authorization to proceed in nuclear security issues. Annex 1 of the ENSREG Declaration [1] specifies the objectives and content of the re-assessment and, in addition, determines the players and deadlines of the re-assessment. Since the responsibility for safe operation of the plants lies primarily with the operators, the re-assessment is to be carried out by the operators. The reports on the re-assessments are evaluated by the competent national authorities, and each national authority prepares and submits its National Reports for the European Commission on the safety of the nuclear power plants operated within the territory of the given member state. These reports will be subject to independent peer review by an international task force consisting of experts delegated by safety authorities of the EU member states.

The Hungarian Atomic Energy Authority (HAEA) officially sent the detailed requirements for the re-assessment [2] to the operator of the single nuclear power plant in the territory of Hungary, to the Paks Nuclear Power Plant Ltd (Paks NPP) and requested the Licensee to execute the re-assessment (TSR). Taking into account the very tight timeframe, it was not possible to accomplish all the detailed analyses of the re-assessment, in some cases it may only set out the objectives of further analyses and examinations and makes the further measures dependent on the analysis results.

Paks NPP submitted its TSR Progress Report [3] to the HAEA on August 11, 2011. The authority reviewed the report, evaluated its conclusions and developed the Preliminary National Report [4] and sent it to the European Commission by the required deadline. The preliminary reports of the member states participating in the stress test have been evaluated by the Commission and the Commission prepared its own report for the European Council and Parliament [5].

Paks NPP prepared the final report [6] on the implemented TSR process by the specified deadline and submitted it to the HAEA on October 28, 2011 for regulatory review. The HAEA developed the present report, as based primarily on the final report of Paks NPP and supplemented it on the basis of the documents already available at the authority, including those prepared during authority inspections.

The Targeted Safety Re-assessment of Paks NPP focuses on the topics specified by the ENSREG: the issues corresponding to earthquake and flooding and other external natural hazard factors, to the loss of electric power supply and loss of ultimate heat sink or combination of those, and to severe accident management. In relation to the hazard factors it was evaluated whether the design basis of the plant is duly determined and what margins the plant has beyond its design bases. It had to be evaluated if the availability of the two most important resources from the aspect of maintaining the

nuclear safety functions, i.e. the ultimate heat sink and the emergency electric power supply have appropriately large margins and that what timeframes and which tools are available for the plant to recover the controlled state in case of loosing these resources (alone or in combination) due to any reason. In the third topic, it had to be revealed in relation to severe accident management that what organizational preparedness and tool sets are available at the plant. As a special aspect, the organizational solutions were examined that might be applied in case of an extreme natural disaster or in situations when more than one unit would suffer severe damages simultaneously on the site or jeopardized severely to do so.

The National Reports of the 14 member states of the EU operating nuclear power plant and the two neighbouring countries (Switzerland and Ukraine) that joined the stress test process will be subject to a peer review in the organization of European Commission. In this process Hungary also actively participates through the delegates of the HAEA. In the first phase the review will be grouped around the three main topics, and in the second phase review missions will visit each member state to clarify any outstanding issue. The Task Force performing the peer review will prepare report for the European Commission.

0.2. Structure of the report

The ENSREG sent the detailed, annotated contents requirements [7] for the national reports to the authorities of the participating countries on November 3, 2011. Later, this document has been published on ENSREG's website. Although it is not mandatory for the participating member states to follow the expectations of the document but it is conceivable that the peer review could only be executed effectively on uniformly structured documents. The report of Paks NPP was developed in the structure required by the HAEA, which was different from that expected by ENSREG.

Disregarding Section 0, the current report accurately follows the structure of [7] to the third level of headings. Beyond that, level 4 headers were introduced, occasionally using the detailed annotations of the ENSREG document as subsection headers.

0.3. Role of the authority in the review

According to the ENSREG requirements the review of the NPPs had to be performed by the operators, while the national authorities had to evaluate the review process, and then based on the submitted report, the results of the review. The national authority had to compile the national report to summarize the results of the evaluation for the European Commission.

In order to ensure that the review process takes place in an adequate manner, the HAEA held an inspection at Paks NPP on July 20, 2011. In the course of the inspection it was revealed that the review was taking place with due progress, the plant had assigned appropriate resources to the review activity (internal and external experts), and the review did not only remain on the level of documents, but also involved a significant number of walkdown inspections. In conclusion, the experiences of the inspection confirmed that the review was taking place in line with the authority requirements and the achievements complied with the regulatory expectations.

After the completion and publication of the Preliminary National Report, the HAEA launched a general inspection procedure to review the TSR activity of Paks NPP. In the course of that, in addition to the evaluation of the report developed by the plant, the HAEA performed further specific inspections and the inspectors of the authority, during their daily routine devoted special attention to the issues belonging to the scope of TSR. The specific inspections included participation in an emergency response exercise performed in September for the application of the severe accident management guidelines, witnessing of the testing of electricity supply by the severe accident diesel generators in October and, during November, the review of the measures that became necessary due to the low water-level of the River Danube. The HAEA will terminate the

general inspection procedure after the publication of this report, by issuing an authority resolution. Further information on that can be found in Section 7.

0.4. Legal and regulatory requirements

The legal framework of the use of atomic energy is laid down in the Act CXVI of 1996 on Atomic Energy, which has been amended many times since issuing. The Act, among others, determines the basic safety functions, the role of the state, and clearly declares that “the user of atomic energy is responsible for the safe use of atomic energy and for the compliance with safety requirements”. It determines the authority role to supervise the safe use of atomic energy and empowers the government to regulate in government decrees the detailed requirements for the safe use of atomic energy. The Act provides: “The Licensee and the atomic energy supervision body shall analyze and evaluate in full scope the nuclear safety of nuclear facilities, in compliance with nuclear safety requirements, level of hazards before construction and commissioning and, by taking into account the operating experience and new knowledge in relation to safety, it shall be done on a regular basis during the whole life span (in the frame of the periodic safety reviews and reports). The results of this activity shall be published in their websites.” In compliance with that, the Paks NPP shall perform Periodic Safety Review every 10 years, which took place in 2007-2008 the last time. This review yielded several safety improving actions well before the formulation of the TSR requirements and the measures decided in response to the findings were partially completed or were in progress at the time of the Fukushima accident.

At the reference time of the report (June 30, 2011) the nuclear safety requirements were detailed in the Govt. Decree 89/2005. (V. 5.) Korm. and in its Annex, in the Nuclear Safety Codes (NSC). On August 10, 2011 a new governmental decree and a new NSC entered into force, but this fact did not essentially change the requirements that are applicable for the TSR topics.

According to the NSC requirements, in line with the international practice, the hazards of natural origin with a recurrence frequency higher than 10^{-4} /year shall be taken into account in the design basis. Natural phenomena of lower frequency can be screened out of the design scope; however, the risks of such events shall still be determined. The TSR has confirmed that the design basis of Paks NPP for natural effects is duly determined and the equipment important to safety have due margins to withstand to an acceptable extent the beyond design basis effects. Since at the time of construction of the plant there were no requirements for the beyond design basis cases, the plant could comply with such requirements only after adequate modifications. As a pre-condition for the planned service life extension the authority required that the modifications necessary for the management of beyond design basis events and severe accidents shall be completed prior to the expiry of the original design lifetime of each given unit.

The new edition of the NSC prescribes, in general, the main frames and requirements that determine the design basis of the plant. These requirements are in compliance with international practice and expectations (IAEA safety standards and WENRA reference levels¹). The NSC also requires that the operators of nuclear power plants have appropriate (objective organizational and administrative) preparedness to mitigate the consequences of beyond design basis events.

Detailed information on the legal background of nuclear safety and regulatory frames, as well as on the general nuclear safety situation in Hungary can be found in the report prepared for the 5th review meeting of the Nuclear Safety Convention [8].

¹ WENRA: Western European Nuclear Regulators Association. The association elaborated a general nuclear safety requirements system, which is referred to as „Reference Levels”, and it became the requirements of the European Union which the member states shall comply with.

1. General data about the sites and nuclear power plants

In Hungary, there is only a single nuclear power plant site with four units of VVER-440/213 type reactors. A brief description of that site and power plant is given below.

1.1. Brief description of the site characteristics

The site of Paks NPP is located 5 km south of the city centre of Paks, 114 km south of Budapest, 1 km west of the River Danube River and 1.5 km east of the main road No. 6. The elevation of the site is at Bf 97.15 m (above Baltic Sea level). An aerial photo of the site can be seen in Figure 1-2.

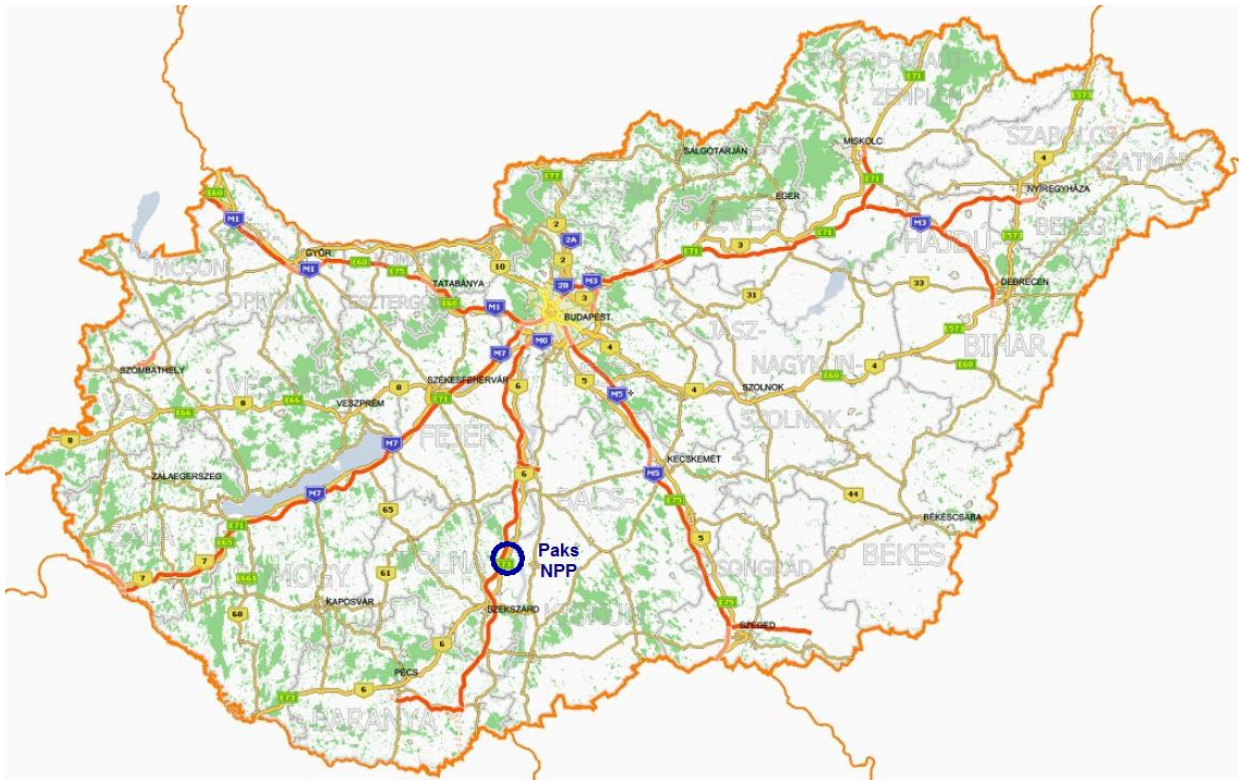

Figure 1-1: Location of Paks NPP

The plant obtains the cooling water for operation directly from the Danube. Since direct cooling technology is used, there are no cooling towers at the NPP units. The water from the river is directed to the water intake structure of the plant through the cold water canal. The primary strainer is placed where the canal branches from the river.

The pump stations in the two water intake structures (serving a pair of units each) deliver the water towards the units for various cooling purposes (condensers, process consumers, safety systems). The heated cooling water returns first in closed pipes, then through the open discharge water canal via an energy breaker structure into the river.

In cold periods, to prevent icing by continuously melting the ice floating in from the Danube, it is possible to mix partially the discharge water into the cold water canal.



Figure 1-2: Paks NPP site

1.1.1. Main characteristics of the units

The four units on the site are placed in two building structures in a twin arrangement. The first building houses Units 1 and 2 (called Installation I), while the second houses Units 3 and 4 (Installation II).

The licensee of the site is Paks Nuclear Plant Limited, which has been acting in the current corporate form since April 14, 2006. The majority (99.99%) shareholder of the plant is the state owned Hungarian Power Companies Ltd.

The four units of the plant are of type VVER-440/V-213, soviet designed light water cooled, light water moderated pressurized water reactors. The licensed normal thermal power of the units is 1485 MW, the electric output is 500 MWe, which has been achieved by a two step power uprate from the original 440 MWe. Capacity of the whole plant is accordingly 2000 MWe.

Normal values of the main technological parameters are described in Table 1-1.

Table 1-1: Main technological parameters of the units

Parameter	Value
Thermal power of reactor	1,485 MW
Primary coolant volume flow rate	42,000 m ³ /h
Primary pressure	123 bar
Primary circuit cold leg temperature	267 °C
Primary circuit hot leg temperature	299.5 °C
Shutdown boric acid concentration	13.5 g/kg
Fresh steam pressure	46 bar
Fresh steam mass flow rate	2,940 t/h
Fresh steam temperature	255 °C

The dates of first connection of the units to the national electricity grid are as follows:

- unit 1: December 28, 1982,
- unit 2: September 6, 1984,
- unit 3: September 28, 1986,
- unit 4: August 16, 1987.

1.1.1.1. Characteristics of the spent fuel pools

The double cladded spent fuel pools that are located in the direct vicinity of the reactors but outside the containment serve to temporary storage of the spent fuel assemblies. A channel with a lock gate connects the spent fuel pool to the upper part of the concrete cavity (called refuelling pool) encapsulating the reactor.

During refuelling of the reactor, the refuelling pool and the spent fuel pool are connected to each other and constitute a single water volume. If no operation is going on, the spent fuel pools are covered by concrete plates and the lock gates separates them from the refuelling pools. In this state the lock gate becomes part of the boundary of the hermetic compartments (containment). This arrangement holds in normal operation, as it is shown on the left side of Figure 1-3. The right side of the figure shows the shutdown state with disassembled reactor, prepared for refuelling. The refuelling pool is filled and the lock gate is removed for that purpose.

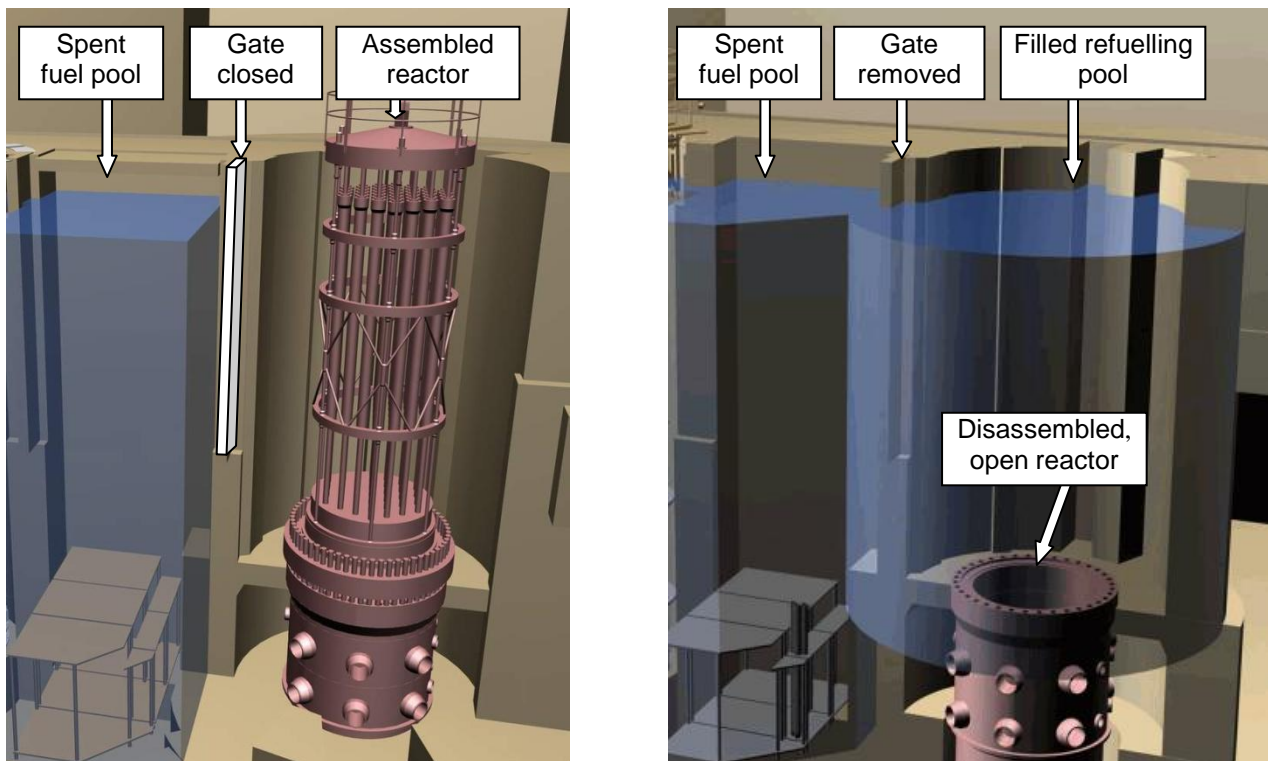

Figure 1-3: Various service modes of the spent fuel pool and the refuelling pool

The spent fuel pool allows the storage of fuel assemblies in two different rack systems at two levels. The normal operational storage rack is located at the bottom of the pool and has a capacity of 650 fuel assemblies and 56 hermetic casings. The hermetic casings are to store and isolate fuel assemblies containing fuel assemblies that are suspected to be leaking.

For those rare and short periods when it becomes necessary to completely unload the reactor vessel, a spare storage rack is positioned above the operational racks. (When not used, the spare racks are stored in the reactor hall.) The capacity of a spare rack is 350 fuel assemblies.

The operational and spare storage racks are shown in Figure 1-4. The structural design and geometry of the operational rack ensures that the pool is always in subcritical state (even without boron in the water).

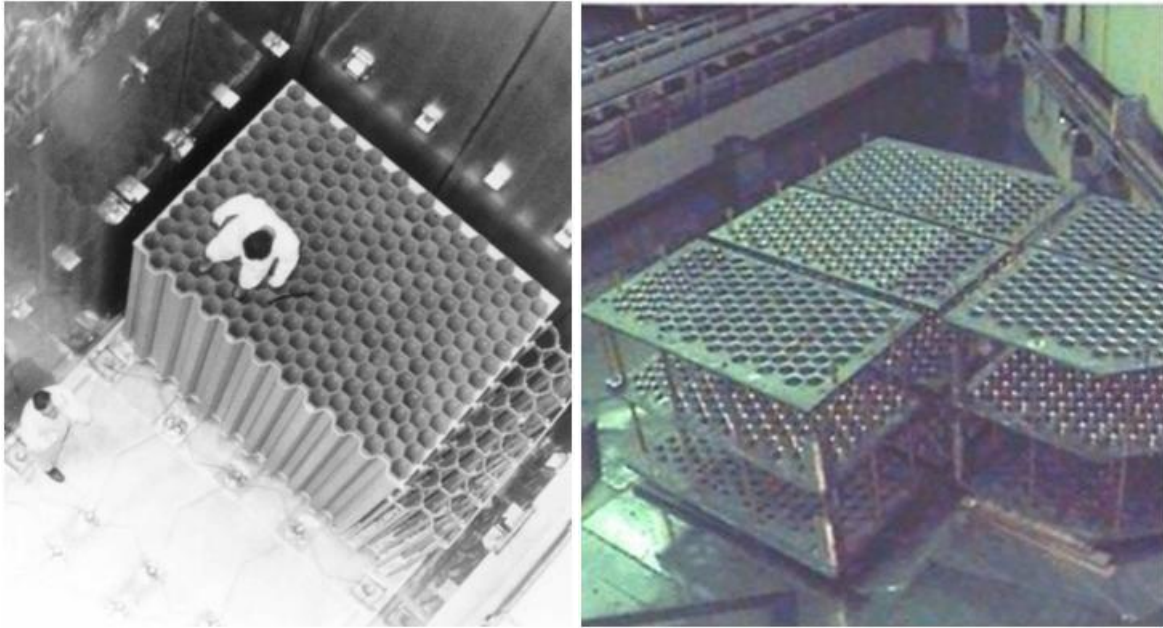

Figure 1-4: Operational and spare rack of the spent fuel pool

Due to the recently introduced improved emergency operating procedures the probability of damage of the fuel stored in the spent fuel pool is compliant, i.e. very low. However, if there was an accident in the pool, radioactivity would be released directly to the reactor hall and from there to the environment. As a result, the effects of the release could be significant, although the environmental consequences would be less severe than for a beyond design basis or severe reactor accident due to the decay period of the fuel.

1.1.2. Description of the systems for conduction of main safety functions

1.1.2.1. Technology of the VVER-440/V-213 units of Paks NPP

The process systems of the plant can be divided into two main groups: primary and secondary circuit systems. The most important components are:

Primary circuit:

- reactor pressure vessel (RPV) and its head with the control rod drives,
- main circulation pipelines and main gate valves,
- main coolant pumps (MCPs),
- steam generators (SGs),
- pressurizer.

Secondary circuit:

- saturated steam turbines,
- generators,
- main condensers,
- main condensate system,
- feedwater system with feedwater tanks and pumps.

The outline of the process components of the plant is shown in Figure 1-5.

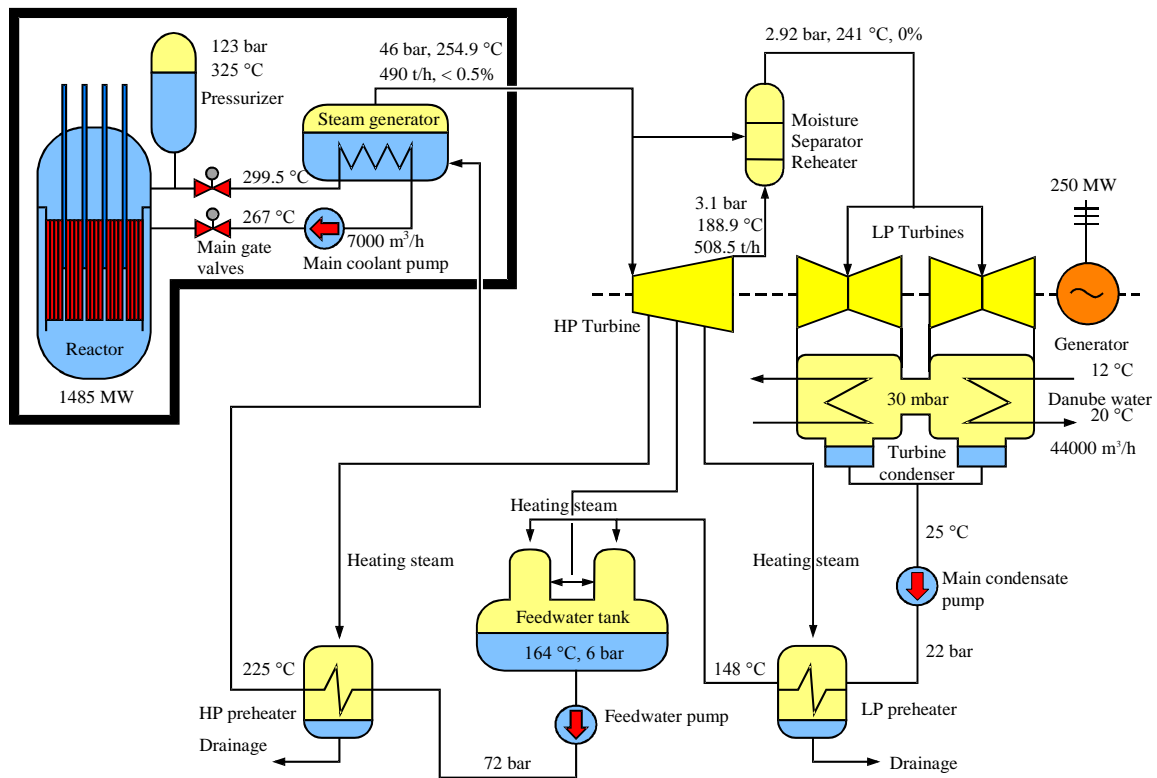
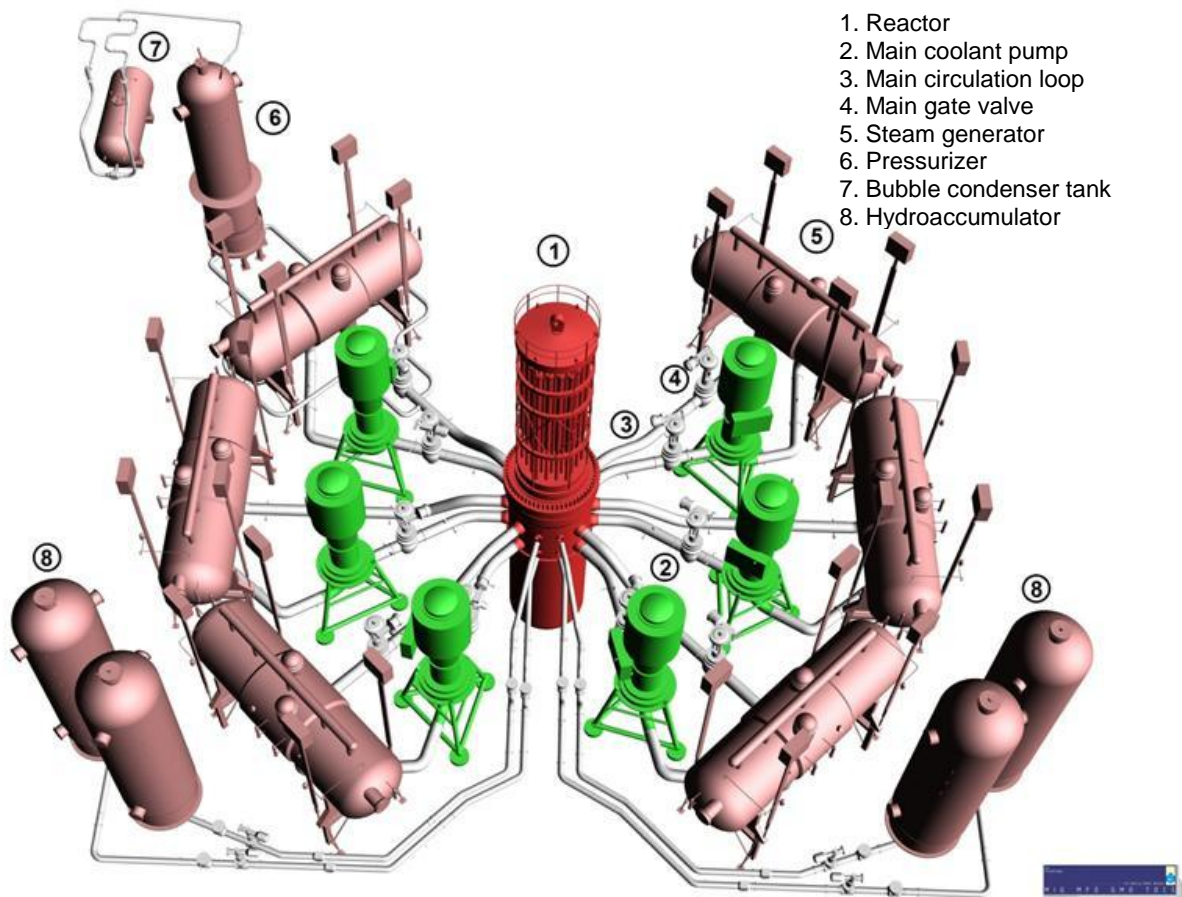

Figure 1-5: Process scheme of a unit

Both installations of the plant have an auxiliary building, their main purpose is the storage and treatment of various liquid and solid contaminated and radioactive wastes and to house the process systems for waste treatment. Separate buildings house the emergency diesel generators for the emergency electrical power supply (3 for each unit). To provide cooling water for the power plant from the Danube, each of the twin units has a pumping station on the bank of the cold water canal.

1.1.2.2. Main equipment of primary circuit

The primary circuit of 123 bar service pressure consists of the reactor vessel, producing 1485 MW thermal power, six parallel cooling loops and a pressurizer vessel connected to one of the loops. Each of the six loops contain a main circulation pump, a steam generator and two main gate valves at both of the hot and cold legs, consisting of stainless steel pipeline of 500 mm diameter. Scheme of the primary circuit can be seen in Figure 1-6. The primary circuit is situated within a system of hermetic compartments designed for overpressure (hermetic compartments or containment). The two hermetic compartments of a twin unit are encompassed in the common reactor building.



1. Reactor
2. Main coolant pump
3. Main circulation loop
4. Main gate valve
5. Steam generator
6. Pressurizer
7. Bubble condenser tank
8. Hydroaccumulator

Figure 1-6: Arrangement of main equipment in the primary circuit

Reactor

The reactor equipment can be divided into two main parts: the pressure vessel contains the active core and the reactor head, which close the vessel from above. The reactor pressure vessel is a vertical, cylindrical vessel with elliptical head and bottom. The vessel is made of high strength alloyed carbon steel, the inner surface of the vessel and of the lid as well as the main plane of the split is clad with corrosion-resistant steel (cladding) to limit corrosion.

Reactor head

The purpose of the reactor head is to close the reactor pressure vessel from above and to hold the control and safety rod drive mechanisms, cables and connections of the in-core measurements and the penetrations of the measurement cables and the sealing thereof. Movement of the safety and control assemblies is performed by electric motors through a rack drive mechanism. The motors elevate or descend or hold the control assemblies at a given position.

Fuel

The VVER-440 plants use low-enriched, ceramic uranium-dioxide fuel. In Paks NPP, the maximum enrichment of ^{235}U in the fuel is 4.2%. The ceramic UO_2 fuel is in the form of 7 mm diameter and 10 mm height pellets which are filled into 2.5 m length and 9.1 mm outer diameter zirconium cladding tubes, forming the fuel rods. In the hexagonal prism shaped fuel assemblies there are 126 such fuel rods.

The active core consists of 349 fuel assemblies, out of which 312 contain only fuel and 37 are control and safety assemblies which consist of two parts. Their upper parts are the control rods, made of neutron absorbing boron steel, while the lower parts are the so-called follower fuel assemblies. When these structures are at their uppermost positions, their fuel follower parts are in the active core, thus participate in energy production. If the control rods are in their lowermost

position, their boron steel parts descend into the core (meanwhile their fuel parts descend underneath the core), thus stopping the chain reaction.

In Paks NPP 11 months long fuel cycles are applied. The fuel assemblies of latest design are applicable for 4-5 cycles (reshuffled within the core during refuelling outages).

Steam generators

The main function of the steam generators is to transfer the heat produced in the reactor to the secondary coolant and to separate hermetically the primary and secondary circuits from each other. Steam generators are horizontal heat exchangers of 3.2 m diameter and of 12 m length, with horizontal heat exchanger tubes and elliptic heads at both ends. Six steam generators connect to the six primary loops. The primary coolant flows inside the heat exchanger tubes, which are arranged in bundles facilitating the heat transfer from the primary coolant to the secondary coolant. Due to the pressure difference between the primary and secondary circuits, the steam generators produce dry, saturated steam to drive the turbine.

Pressurizer

Any positive and negative changes of the primary pressure are compensated and controlled by the pressurizer equipment connected to the non-excluded part of one of the loops, which also facilitates the control of the amount of primary coolant.

The pressurizer is a vertical vessel of 12 m height with a total volume of 44 m³. At the lower part of the vessel there are 108 electric heating units connected to the cylinder of the vessel. In order to increase the pressure in the primary circuit these heating units are turned on, elevating the pressure through the increase of the temperature. In order to decrease the pressure, colder water is sprayed into the upper volume of the vessel from the cold leg and the heating units are switched off.

The overpressure protection system of the primary circuit is connecting to the pressurizer, which limits the pressure of the primary circuit at a specific value. The system of safety valves provides the relief of the overpressure from the pressurizer into the bubble condenser tank, which is protected against overpressure by a rupture disk, releasing eventually into the containment.

Reactivity control function

In line with the requirements, two, independently operating reactivity control systems based on different principles provide the reactivity control and safe shutdown of the reactor, maintaining its subcritical state. The fast shutdown of the reactor is carried out by the dropping down the safety and control assemblies into their lowermost position, while the slow shutdown tool is the make-up and boron control system that can inject boric acid into the reactor. Both systems can operate automatically.

The purpose of the make-up and boron control system (among others) is to compensate the slow reactivity change by decreasing the boric acid concentration of the primary circuit. In emergency cases the function is opposite, as part of reactor protection intervention the system, it injects boric acid into the primary circuit, thereby ensuring the subcritical state.

Both systems continuously operate in normal service and participate in maintaining the required power level in critical state by fine tuning of the control rod positions and by injecting the required amount of clean or borated coolant. The make-up system is also applied for injecting different chemical agents into the primary circuit.

1.1.2.3. Main equipment of secondary circuit

Turbine and generator

The dry, saturated steam generated in the six steam generators is directed to the two turbine sets of 250 MW electric output each by the main steam system. During cooling down and in emergency situation the main steam system is the main equipment for heat removal from the primary circuit through the steam generators. The pipe connections are such that one of the turbines receives steam

from the odd, while the other from the even steam generators. This solution provides symmetric cooling of the reactor even if only one of the turbines is in service.

The heat and kinetic energy of the steam generated in the steam generator is transformed into rotation and drives the generator to produce electric current. The turbine has three stages, consisting of one high pressure and two low pressure stages. The stages are located each after the other in the same line; their shafts are interconnected with rigid coupling. Generator shaft connects to the shaft of the low pressure stage of the turbine. There are two sets of turbo generators for each unit.

Main condensate, feedwater and emergency feedwater systems

The exhausted steam in the turbine goes to the main condenser, where it condensates by the coolant. The generated precipitation is be re-injected to the steam generator to close the process. This function is realized by two systems: operational and emergency feedwater systems. The main condensate system delivers water to the feedwater tank from the main condenser after pre-heating.

The feedwater system delivers the feedwater stored in the feedwater tanks to the steam generators after pre-heating and takes part in the cooling down and heating up of the primary circuit.

There are several pumps installed in the main condensate and feedwater systems which can fully replace each other.

If a failure occurs in the operational feedwater system, the emergency feedwater system takes over to perform the supply of feedwater to the steam generators in order to provide cooling of the reactor. The system, unlike the operational feedwater pumps, directly connects to the feeder pipeline bypassing the pre-heaters.

Demineralised water system

The purpose of the demineralised water system to provide feedwater reserves for the units and make-up for the loss of secondary coolant by injection to the main condensers or to the feedwater tanks. In emergency situation its further important function is to supply cooling water for the auxiliary emergency feedwater system. One demineralised water system is available for a twin unit. It means that one system belongs to Installation I (Unit 1 and 2) and one belongs to Installation II (Unit 3 and 4). The water demineralization station supplies the demineralised water from the Danube. Demineralised water is stored in three 900 m³ tanks (Figure 1-7) for one installation.

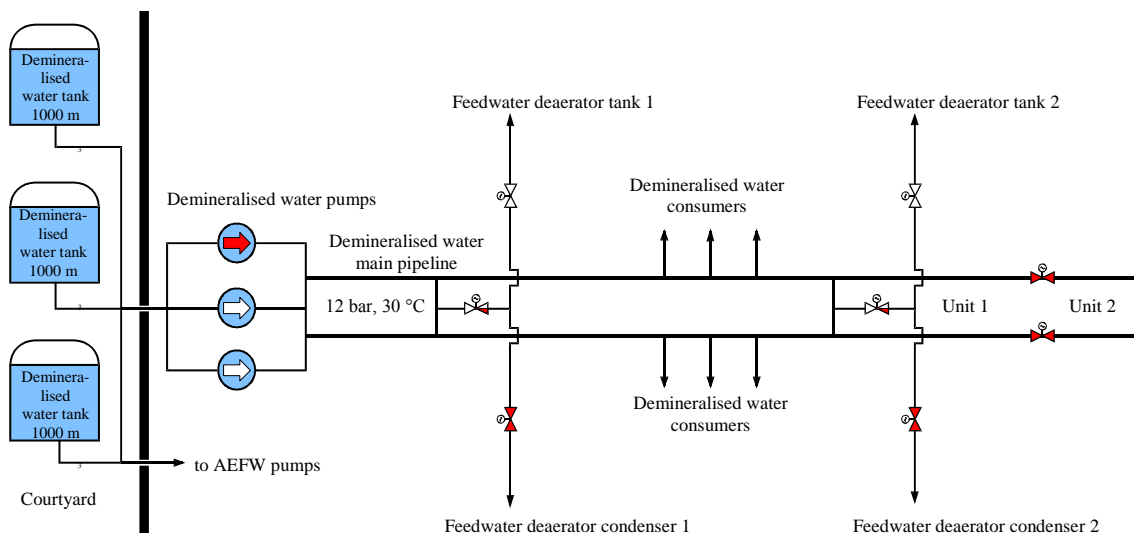

Figure 1-7: The scheme of a demineralised water system

1.1.2.4. Electrical system of the plant and external grid connections

External connections

The produced electric power is delivered through the 400 kV and 120 kV substations to the national grid, which also provides the opposite direction power supply. The two main transformers that belong to one reactor unit connect through a common 400 kV unit line to the 400 kV substation, which is part of the Hungarian national basic grid. The reliability of this substation is an important element of the reliable operation of the plant. Connections of the 400 kV substation are shown in Figure 1-8.

The 400 kV system supplies the dual bus-bar 120 kV substation through two booster transformers. It delivers the energy produced towards the national main distribution grid and, in addition, connects to the backup starting transformers of the plant, which provides the power supply of the plant from the national grid at 120 kV level too. The 120 kV substation provides backup supply to the plant from its basic grid through the 120/6 kV transformers.

The substations of Paks NPP connect to the national basic grid (400 kV) via five various direction transmission lines, while it connects to the national main distribution grid (120 kV) via the booster transformers and seven transmission lines. This electric power connection system ensures due safety for the cases if part of the transmission lines fails.

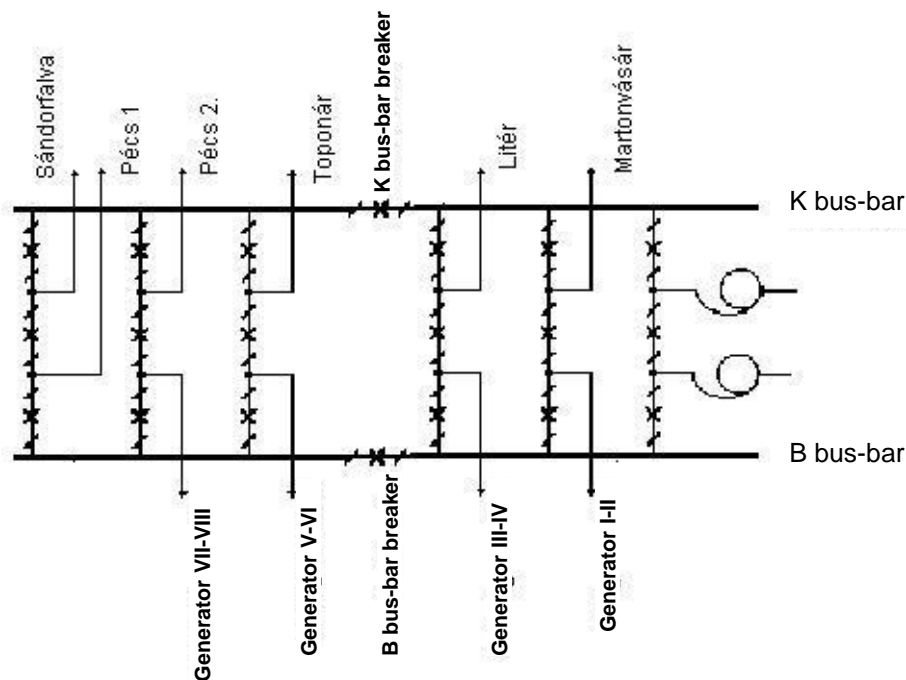

Figure 1-8: Logic diagram of 400kV external connections

In-house service electric system

The systems ensuring the in-house service electric supply of the plant belong to three categories according to the allowed duration of loss of voltage:

- In the case of category I, the uninterrupted direct and alternating current supply equipment, the duration of loss of voltage shall not exceed a fraction of a second. Category I consumers are safety measurements, automatics, signals and intervening instruments. Their direct electrical power sources are the batteries, the capacities of which are sufficient for minimum 3.5 hours, even at the highest load.
- In the case of category II, usually safety essential consumers supplied by alternating current, the duration of loss of supply shall not exceed a few minutes. Category II consumers are active safety components having greater power needs (e.g. pumps). The ultimate electric

power sources for the consumers supplied by Category II electric power are the emergency diesel generators.

- There is no time limitation for the loss of electric supply of category III electric equipment. They do not have safety function; they are supplied from the unit, backup and in-house transformers.

The purpose of the 6 kV in-house system is to supply the normal supply engines of the plant with electric power and through the 6/0.4 kV transformers the 0.4 kV in-house service of the plant.

In normal service the Category II 6 kV distributors are also supplied from the category III 6 kV unit distributors through serial bus-bar breakers.

In normal operation the 6 kV in-house service unit distributors are supplied through their service distributors from the in-house transformers which are connecting the generators and the unit transformers. The backup supply of the distributors is in connected position, the voltage of the backup bus-bars is supplied from the backup transformers. The switching automatics between the service and backup supplies of the distributors are actuated in normal service. The position of the transformer branches is connected, switched on, supply of the 0.4 kV in-house service system is supplied through them.

1.1.2.5. Unit control room and other operating rooms

The control of the processes of the nuclear power plant, depending on the functions to be performed, is carried out in various places: in control rooms and operating rooms designed for various functions. The tasks corresponding to the operation of the primary circuit, secondary circuit and electric equipment are performed from the unit control rooms of each unit. In normal situation the unit control room is manned by four positions: unit supervisor, reactor operator, turbine operator and electric operator. A picture of a main control room is shown in Figure 1-9.



Figure 1-9: Picture of unit control room

If the unit control room is lost, the backup control room is available to shut down and cool down the unit. Control of the systems that are common for two units takes place from the common service control room. The Shift Engineer supervises the operations of the whole nuclear power plant and manages the emergency response in accident situations from the Plant Control Centre. Further operating rooms serve to servicing the various systems:

- water intake control room serves for the operation and control of the systems that intake the water from the Danube,
- auxiliary building control room serves for the operation and supervision of the auxiliary building technologies,
- dosimetry control room serves for the control of radiation conditions in the plant,
- electric grid control room serves for the control and supervision of delivering the electric power to the national basic grid,
- and several local operational posts.

1.1.2.6. Safety systems

Those systems belong to this category which are necessary to ensure that the consequences of any internal or external initiating event within the design basis remain within the required limits.

According to the defence-in-depth concept the safe operation of the plant, in addition to the normal service system, is guaranteed by engineered protections, safety and localization systems.

The most severe design basis accident of the units is the total cross-section (200 %) break of the main primary circulation pipeline, assumed together with loss of off-site power.

The reactor protection and safety systems are organized into 3 independent, redundant trains, out of which a single train can totally fulfil the required safety functions. The main elements of such a train are as follows:

- reactor protection system, which takes care of prompt shutdown of the reactor if certain conditions are met,
- emergency core cooling system, which ensures the removal of decay heat from the shutdown reactor core even if the normal service systems become inadequate to do so or the integrity of the primary circuit is lost,
- digital automatics – measurement and control system, which provide the measurements required for the interventions, necessary evaluation logics, signals and which initiate the interventions automatically,
- systems providing the resources and conditions required for the operation of all these system: the emergency diesel generators to supply electric power, essential service water system branches to provide the connection to the ultimate heat sink, and further auxiliary systems to provide other safety conditions.

Reactor protection system

Emergency shutdown of the reactor is activated by the reactor protection automatics, which is part of the safety control systems, for the signal of which the drives release the 37 control and safety assemblies and let the boron steel part of the assemblies fall freely into the active core, while the follower assemblies descend underneath the core. Analyses demonstrate that even if the most worthy control assembly and another one stuck in the upper position, the shutdown of the chain reaction still is ensured with high reliability.

The conditions of emergency shutdown are provided by the safety control system constructed with threefold redundancy, by a 2 out of 3 voting logic. Measurements required for the detection of the conditions are also installed with threefold redundancy.

If the electric supply of the drives of the control and safety assemblies is lost then the assemblies will fall freely into the reactor irrespective of the control logic.

Emergency core cooling systems

The emergency core cooling systems are the basic safety systems of the unit, the common task of which is to recover the cooling of the core by supplying borated cooling water to the active core in the course of loss of coolant accidents, which prevents the damage to the fuel assemblies and radioactive release. The emergency core cooling systems of the reactor core are classified into three groups according to their functions and operation principle:

- passive system,
- high pressure injection system,
- low pressure injection system.

The passive system consists of four independent hydroaccumulator tanks,, which store appropriate volume and concentration boric acid solution. The function of the hydroaccumulators is to keep the reactor core covered by water during large break loss of coolant accidents. Nitrogen pillow provides the necessary pressure of the hydroaccumulators. All tanks are connected to the reactor pressure vessel through separate pipelines and a check valves.

The high and low pressure injection systems are designed with threefold redundancy and consist of independent subsystems appropriately separated of each other, according to the three train approach of the safety systems. Each train of the systems was designed to fulfilling the required function alone. The main elements of each of the trains are the applicable pumps and respective tanks. Actuation of the systems is carried out via the instrumentation and control system, their operation needs electric power, which is provided from the Category II safety supply.

In case of a loss of coolant accident – depending on the pressure conditions in the reactor – , the first system to actuate is the high pressure emergency injection system. This system performs the recovery of cooling by injecting boric acid solution of 40 g/dm^3 concentration into the reactor. If the pressure further decreases due to the leak, the supply from the passive hydroaccumulators starts when the pressure falls below 35 bar. It also injects boric acid solution of 40 g/dm^3 concentration. This guarantees the subcriticality of the reactor and also avoids re-criticality due to cooling down. The low pressure system actuates at 7.2 bar, injects boric acid solution of 13.5 g/dm^3 and performs the cooling of the active core.

If all of the emergency core cooling water tanks are emptied, then both the high pressure and the low pressure systems switch to recirculation mode. In this case, the water accumulated on the floor of the containment is re-injected to the primary circuit by the low pressure emergency core cooling pump from the sumps installed into the containment floor. In recirculation mode the water is cooled by the sump heat exchangers.

Safety instrumentation and control systems

In the frame of modernization of the safety instrumentation and control system of the 4 units of the NPP between 1999 and 2002, a brand new, integrated system was installed, which alone realizes the functions of several independent instrumentation system of the original VVER-440/213 design. The new system is based on the TELEPERM-XS system produced by the Siemens.

The function of the safety instrumentation and control system is to control the safety of the reactor, to keep the technological and nuclear parameters within the limits, to avoid, if necessary, the power increase of the reactor, to decrease the power of and to shut down the reactor. Further function of the system is automatic start-up and control of operation of the emergency core cooling system, if necessary.

The system, according to the redundancy of the technology consists of three identical structure sets, each of which has full capacity alone, corresponding to the three safety system trains. All the sets are identical and apply digital (computerized) signal processing.

If the parameters of the unit exit the allowed envelope, the reactor scram is initiated automatically by the reactor protection system. Under specified conditions, the operation different safety systems

is also initiated. The reactor protection system provides opportunity for manual shutdown or manual operation of the safety systems by the reactor operators.

Essential service water system

The function of the essential service water system (ESWS) is to supply components with cooling water, which require safe and permanent cooling during normal operation of the unit or required in normal or in emergency cooling down of the unit.

There is an ESWS for each of the two installations, consisting of three independent branches. It is supplied with water by two coolant pumps for each branch, which are located in the water intake structure at the cold water canal.

The most important consumers of the system are as follows:

- emergency diesel generators (cooling water),
- cooling down system (main condenser cooling, pump bearing cooling),
- emergency core cooling system (sump coolers, pump engines, room venting, intermediate cooling circuit),
- cooling of spent fuel pool and also its pumps
- main coolant pumps (intermediate circuit coolers, oil coolers).

According to the requirements for safety systems the system has threefold redundancy with two cooling water pumps in each branch (altogether 6 pump/twin units) that take cooling water from the cold water canal through a pre-screening facility.

In normal service 3×1 pumps operate for one installation, in emergency all the six pumps are started. The check valves at the outlet of the pumps prevent the system from emptying when the pumps stop. The water delivered by the pumps from the water intake structure reaches the turbine hall through filters and three underground pipelines of 700 mm diameter. Each redundant branch connects to a separate storage tank of 100 m³, which provides temporary cooling water reserve for the system for the case of total loss of power. The pipelines of the systems are common for a twin unit up to the storage tanks and then ramify towards the two units.

The capacity of the plants is designed to supply simultaneously one unit handling a large break loss of coolant accident, while the twin unit is in normal cool down process. The nominal delivery of a pump is 1656 m³/h, which meets the specified demand. It can be determined with high confidence that the pumps can take water from the canal even if the low water-level of Bf 83.5 m of the Danube is assumed, which has a frequency less than 10⁻⁴/year.

The required mechanical independence is realized by the individual branches (filters, pumps and pipelines), while the electric and instrumentation supply is provided by different safety electric distributor trains for each system. Regarding civil engineering, the ESW pump station is placed in the common water intake structure for a twin unit, but they are well separated on system level and constructed in separate rooms. The primary guarantee of compliance with single failure criterion of the ESW system is the applied redundancy and independence of the redundant branches.

The electric power supply of the ESW pumps is Category II (see: In-house service electric system), it is provided from the 6 kV safety essential system, which means that the pumps can fulfil their function even if loss of off-site power takes place. The ESW system needs no fuel supply, neither requires separate cooling, nor has any oil system. Thus the operability of the ESW system is not limited by fuel, coolant or lubricant supply.

The protection logic starting the ESW pumps and actuating the valves is constructed with threefold redundancy within the safety instrumentation and control system, which is in harmony with the redundancy of the technology. A relay logic installed in the switching cabinets provides priority for the protection signals against the operator commands. Local operation interventions are not required at the ESW components, since they are remotely controlled. The system can be controlled from the unit control room, backup control room or from the water intake structure control room.

Auxiliary emergency feedwater system

If the operational or the emergency feedwater systems fail, it is the purpose of the auxiliary emergency feedwater system to supply the steam generators with feedwater. This system has an injection route to the steam generators independent of the normal operational feedwater system, and directly uses the water reserves of the demineralised water tanks to remove the decay heat from the reactors.

Cool-down system

Functions of the cool-down system:

- Cooling down of the primary circuit at appropriate rate through the secondary circuit in normal or emergency shutdown.
- Removal of decay heat generated in the shutdown state of the reactor.

There is one cooling reducer and one cool-down condenser in both branches of the system (Figure 1-10). Heat removal is realized in the cool-down condenser, which is cooled by essential service water, while the reducer can control the cooling rate.

Normally, a closed circuit heat removal can be realized with the main secondary circuit systems. In emergency or normal operation cooling of the units an open circuit heat removal may also take place by means of the cool-down system. In such a case the steam generated in the steam generator is released to the environment, requiring a need for continuous make-up of the secondary circuit water volume, which is provided by the cool-down system together with the demineralised water system.

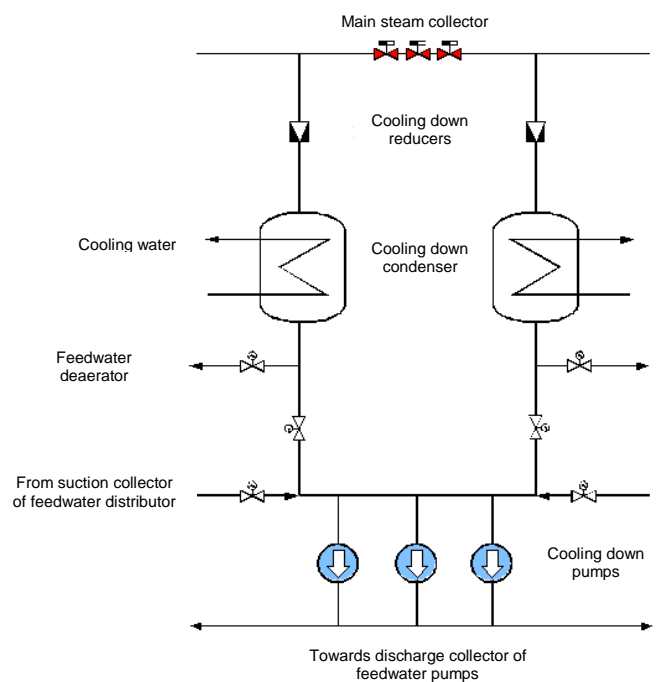

Figure 1-10: Cool-down system

1.1.2.7. Hermetic compartments – containment

The containment of the VVER-440/213 type plants consist of a hermetic building structure that encompasses the primary circuit of the reactor and is designed for overpressure (hermetic compartments) and of the accident localization system having passive and active components. The building structure is designed for the pressure occurring during the maximum design basis accident and its pressure retention function is tested on a regular basis. The allowed leakage rate of the containment system at 1.5 bar overpressure is $(14.7-\delta L)\%$ per day of the total volume of the containment, where δL is the limit for measurement error. In fact, according to the actual measurements the leakage is much smaller: 4-8%/day at 1.5 bar overpressure.

In normal service, the access to the hermetic compartments is provided via hermetic air locks. In order to provide isolation of the containment there are closing valves on both sides of every pipeline wall penetrations, and the penetrations are of leak-tight design.

If a pipe break or a leakage occurs in the primary circuit, the radioactive medium enters the atmosphere of the containment where, due to the hermetic construction of the compartment system, it causes a pressure increase. This would lead to a release that is proportional to the pressure in the containment. The passive localisation tower with bubbling condenser trays and the active pressure reducing sprinkler system, however, is able to maintain the low pressure in the compartments. The accident localization system designed to retain the radioactive materials consists of the following components:

- passive pressure reducing system (localisation tower),
- sprinkler-system,
- isolation system of hermetic compartments,
- hydrogen management system.

Experiment series and calculations performed in international frames demonstrated that the hermetic compartments and the localization system together fully provide the functionality of a containment system.

Passive pressure reducing system

The localization tower encapsulates the passive parts of the containment pressure reducing system (Figure 1-11). Steam generated after the rupture of the main circulation loop, together with the air of the hermetic compartments travel through the to cross-flow passage to the localization tower.

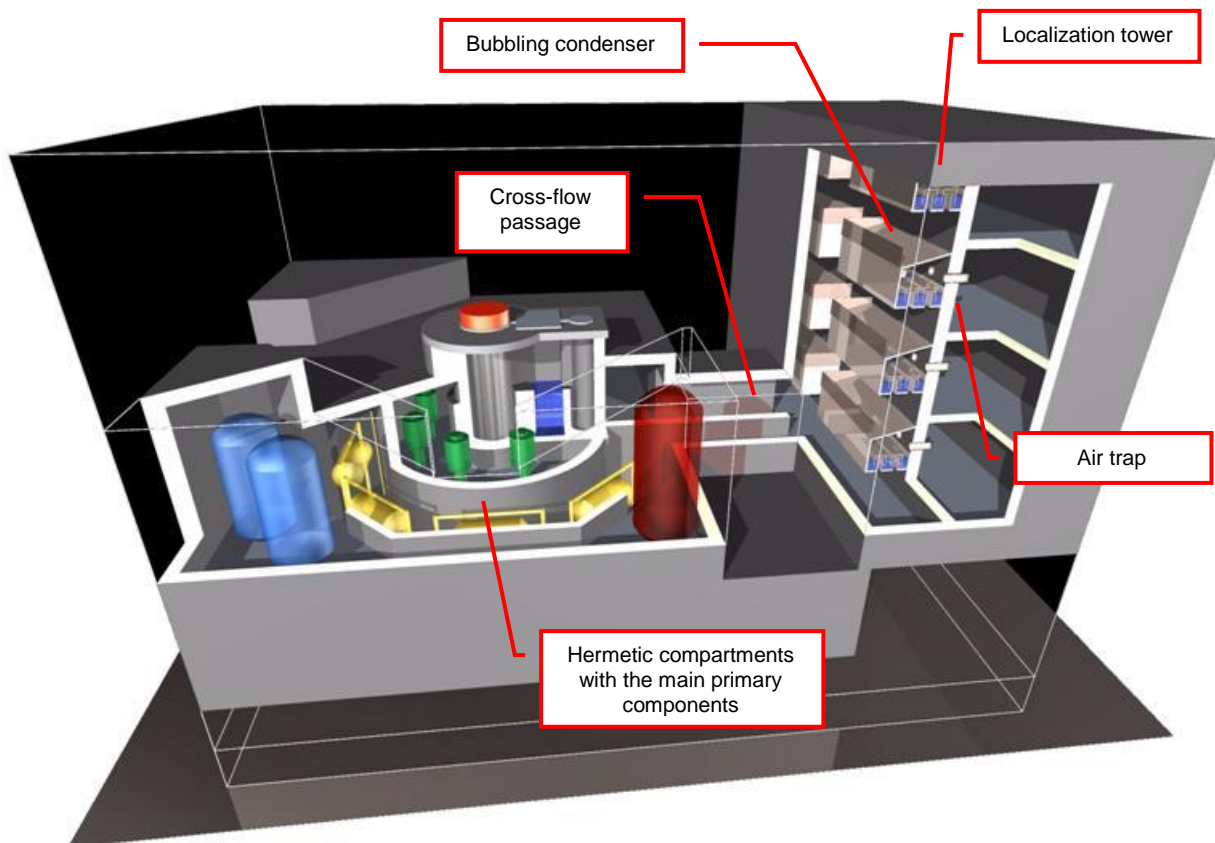

Figure 1-11: Hermetic compartments with the passive pressure reducing system (simplified)

The localization tower consists of two main parts: bubbling condenser trays and the air traps.

As a result of a rupture in the hermetic compartments, the steam-air mixture flows into the localization tower and is forced through slots of the trays of the bubbling condenser. The trays are

arranged at 12 levels and filled with borated water solution. The steam condenses as it bubbles through the water in the trays, while the pressure difference forces the released air to move into the air traps through dual check valves.

As the pressure balances, the bubbling eventually stops and a further decrease in pressure due to condensation on the steel clad walls of the hermetic compartments causes the air above the water level of the trays to push back the water from the trays. The water is then sprayed into the localization tower, further reducing the pressure of the containment.

Sprinkler system

The sprinkler system is an active element of the pressure reduction system in the hermetic compartments. The function of the system is to spray cold water containing boric acid into the hermetic compartments to condensate the steam, decreasing the pressure caused by the accident. It is also a favourable effect that the spray washes out the iodine from the atmosphere of the compartments. The sprinkler system consists of three independent trains, which are located in separated rooms. Each train is designed to fulfil the functions alone.

Sprinkler pumps suck from the low pressure emergency core cooling system tanks containing boric acid solution. Safety automatics actuate the sprinkler system intermittently in order to maintain the containment pressure in the required range.

Isolation system of the hermetic compartments

The function of the isolation system is to isolate the hermetic compartments and the enveloped systems from the environment in case of an accident causing radioactive release into the containment.

In order to ensure due isolation, all of the pipelines penetrating through the wall of the hermetic compartments are provided with isolation valves on both sides of the walls. Isolation takes place by closing of these valves according to defined conditions.

Hydrogen management system

Function of the hydrogen management system is to remove the hydrogen from the hermetic compartments during accidents.

The hydrogen management system consists of passive, autocatalytic recombiners, in which the hydrogen recombines with the oxygen in the air into water. The system does not require power or operator intervention, it actuates automatically if at least 2 volume percentage of hydrogen reaches the recombiners and it will operate while this condition exists. Capacity and placement of the installed hydrogen recombiners are such that they are able to prevent hydrogen explosion even in a severe accident situation.

1.1.2.8. Safety electric power supply systems

The various safety systems have various requirements for the electric supply systems. Accordingly, there are more types of alternate current safety electric power supply grids in the plant: among others, the uninterrupted power supply system including the emergency diesel generator units and the battery systems. For the different safety supply categories see the subsection “In-house service electric system” in section 1.1.2.

In order to provide power for the nuclear safety systems and equipment three identical and fully independent safety electric power supply trains are installed. In the case when the power is lost from the normal service supply or the grid frequency deviates by a specified value from the normal value, the automatic control detaches the safety distributors from the in-house service system, the emergency diesel generators automatically start and the electrical circuit breakers switch there the Category II consumers that are essential for the cooling of the reactor and the spent fuel pool. The power supply is then continuously provided for the consumers. Each train of the threefold safety systems are provided with an individual, independent emergency diesel generator. The 6/0.4 kV

safety transformers that connect to the 6 kV safety bus-bar sections supply the 0.4 kV main distributors and the sub-distribution grid supplied from it. Consumers requiring uninterrupted power supply are energized from batteries until the start up of the emergency diesel generators. A scheme of the electric power supply system in normal service mode of the unit can be seen in Figure 1-12.

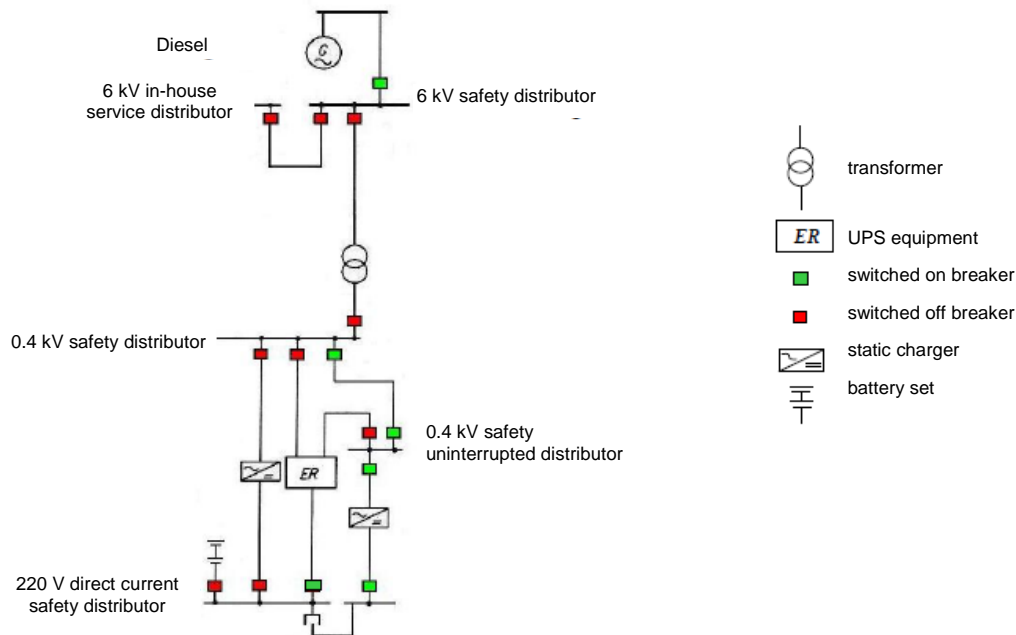

Figure 1-12: Scheme of electric power supply system in normal service mode of the unit

1.1.2.9. Alternative electric power and water supply

If the site of Paks NPP detaches from the Hungarian national grid, but at least one reactor and the connecting electric power generator remains in service, then the operating reactor unit can supply all the consumers of the other units through the 400/120 kV substation of the site.

There are two independent connection points at the outer wall of each unit from which the grid providing the safety electric power supply at 0.4 kV level can be energized. The supply is provided by the severe accident diesel generators available for each unit (see Section 5.1.3.).

In order to provide secondary circuit water supply for the steam generators and to inject water to the hermetic compartments there is a water supply opportunity installed having an external connection point for both twin units (see Section 5.2.3.)

1.2. Significant differences between units

1.2.1. Differences between the Emergency diesel generators

The Emergency diesel generators installed in the twin units are of different make. Figure 1-13 shows the different emergency diesel generators of the two Installations.



Figure 1-13: The emergency diesel generators of Installations I and II

Three emergency diesel generators of type 15D100, 10-twin-cylinder, two-stroke, Soviet (Ukrainian) made, have been installed in the emergency diesel generator buildings of each unit of Installation I. Nominal power of a generator is 1.6 MW, but it can provide 1.8 MW for 10 hours. Nominal revolution of the engines is 750 rev/min; start-up time is $t \leq 15$ sec.

Three emergency diesel generators of type GANZ-SEMT PIELSTIK, 10-cylinder, four-stroke, 4-valve, Hungarian made, of 2.1 MW power have been installed in the emergency diesel generator buildings of each unit of Installation II. Nominal revolution of the engines is 1500 rev/min; start-up time is $t \leq 15$ sec.

1.2.2. Status of severe accident management modifications

An integrated analysis and then a modification programme was launched as far back as the year 2008 to prepare for mitigation of consequences of low probability beyond design basis accidents that might lead to severe damage to the reactor, called severe accidents. The work resulted in several technological modifications required for the introduction of the severe accident management guidelines, most of which are already implemented at Paks NPP; however the completion level of them is different in the various units. The status of the separate modifications in the units is shown in Figure 1-2 (the report was based mainly on the current status of measures in Unit 1).

Table 1-2: Status of severe accident management modifications or scheduled date of implementation

Modification	Unit 1	Unit 2	Unit 3	Unit 4
Construction of reactor cavity flooding system	Implemented	2012 main outage	2013 main outage	2014 main outage
Construction of autonomous power supply to designated consumers	Implemented	Implemented	Implemented	Implemented
Installation of passive hydrogen recombiners	Implemented	Implemented	Implemented	Implemented
Reinforcement of cooling circuit of spent fuel pool against loss of coolant	Implemented	Nov-Dec, 2012	Feb-Mar, 2013	Jan-Feb, 2012
Installation of severe accident measurement system	Implemented	Jun-Aug, 2012	Sept-Oct, 2013	May-June, 2013
Introduction of severe accident management guidelines	Dec 31, 2011	Dec 31, 2012	Dec 31, 2013	Dec 31, 2014

1.2.3. Location of demineralised water storage tanks of Installation II

Provision and preservation of demineralised water requires the maintenance of integrity of the demineralised water storage tanks (three tanks per installation, 900 m³ each). The three tanks of Installation II have been placed in the close vicinity of a service building (Figure 2-5). It is a

reinforced concrete structure building of significant robustness, but formally is not qualified for design basis earthquakes. The wall of the main building is situated similarly close to the tanks of Installation I but it is qualified for design basis earthquakes.

1.2.4. Recovery of essential service water system after emptying

After emptying an essential service water line, during the recovery the pump cannot be started in a normal manner without risking a water hammer effect. In Installation I the problem can be avoided, because an installed closing valve can throttle the delivery side of the pumps, so the system can be filled up by its own pumps without water hammer effect. Concerning Installation II, there is no motor operated valve after the essential service water pumps, so the pumps can be started after only after filling up the line from another system. Filling up from another system is a more complicated, longer process due to the pipeline connections and cross links, but it can be realized. Emptying of the ESW systems are prevented by the in-built check valves in both installations. In accident situations the most probable reason of emptying is the damage to the system, so before filling up a repair of the damage has to be taken care of. Since it is more time-consuming operation than the filling process itself, the described difference would not be important in such a case.

1.2.5. Delivery of fire water into essential service water system

There is a cross-link available at Installation I to deliver fire water to the essential service water system through the technology cooling water system. Only a disconnection valve should open between the systems. This direct possibility does not exist at Installation II, the cross-link between the two systems can only be created through additional steps.

1.3. Use of PSA as part of the safety assessment

1.3.1. Scope of probabilistic safety assessments

Nuclear safety licensing in Hungary is based on deterministic analyses, but the regulations require the implementation of probabilistic analyses too. In line with that, Paks NPP has completed Level 1 and Level 2 probabilistic safety assessment (PSA) studies in relation to the accidents of both the reactor and of the spent fuel pool. PSA analyses cover both the nominal service mode of the units and the low power and shutdown states. Among the initiating events analysed, one can find all the process-related events, as well as fires, internal flooding and earthquakes.

Some parts of the PSA assessments are unit specific, so Paks NPP usually has executed separate analyses for the four units. In some cases it has been sufficient to prepare the assessment only for one selected unit.

Level 1 reactor PSAs relate to the actual state of the reactors; they are updated annually to take into account the modifications during the preceding period.

Current modifications addressing the management of severe accidents have not yet been considered in the Level 2 PSA, so this analysis contains results only for the state without consequence mitigating severe accident management.

Spent fuel pool PSAs cover Levels 1 and 2. Regarding the initiating events they address internal process-based failures, internal fire and flooding risks.

The scope of PSA analyses performed complies with the international practice. It is not complete in the sense that a corrective action decided in the last Periodic Safety Review is not implemented yet. This measure involves the development of the PSA analyses for natural hazards in addition to the existing seismic PSA.

1.3.2. Results of the re-assessment

Objectives and procedures of analyses are in compliance with the recommendations of the Hungarian and IAEA documents.

Methods and computer programs used for the analyses are generally accepted in the international practice.

1.3.2.1. Results of the Level 1 PSA assessments

In line with the international practice, the Hungarian regulation also require that the core damage frequency of each unit shall be less than 10^{-4} /year, while the frequency of a large radioactive release shall be decreased to an acceptable level, at least by one order of magnitude below the core damage frequency by means of accident management measures.

The unit specific analysis results do not show a significant difference between the units, so it is enough to summarize the results of Unit 2 as an example supplemented with the seismic PSA results for Unit 3.

Based on the calculations, the probability that a core damage occurs in Unit 2 during a refuelling cycle or thereafter during shutdown period due to an initiating event of internal origin, a fire or an internal flooding is: $1.71 \cdot 10^{-5}$ /year.

The contributors to the risk are as follows:

- Out of the initiating events that may occur in normal power operation
 - core damage frequency caused by internal events is $5.25 \cdot 10^{-6}$ /year, which decreased two orders of magnitudes compared to the value determined by the baseline analysis in 1995 in the frame of the first Periodic Safety Review of Unit 2 as a result of the performed safety improvement measures;
 - expected value of the core damage frequency caused by internal fires is: $1.97 \cdot 10^{-6}$ /year [dominant contributors are the electrical building (39.0%) and the turbine machine room (33.7%)];
 - core damage frequency due to internal flooding is: $4.30 \cdot 10^{-6}$ /year. Out of the effects the local steam flooding impacting a whole space dominates (> 90%).
- In shutdown states for main overhaul and refuelling
 - core damage frequency caused by internal events is $4.46 \cdot 10^{-6}$ /year, in which the dominating is the state with closed containment (44.3%), but the open reactor, low reactor water level state (26.6%) and the open containment, but closed reactor state (24.0%) are also important;
 - in case of internal fires $2.25 \cdot 10^{-6}$ /year, in relation to internal flooding $2.45 \cdot 10^{-8}$ /year are the values of the core damage frequency;
 - the shutdown risk is mostly influenced by the errors of human interventions.

The expected value of core damage frequency due to an earthquake that occurs in normal power state of Unit 3, taking into account all acceleration ranges, is: $4.31 \cdot 10^{-5}$ /year. Considering all initiating event analyzes, still the earthquake is the most important risk factor.

The distribution of the core damage frequencies over the various acceleration ranges is summarized in Table 1-3. It can be seen that the residual risk from earthquakes originates mainly from earthquakes causing beyond design basis loads. This is due to the results of previously implemented seismic reinforcements.

Table 1-3: Distribution of core damage frequencies over acceleration ranges

Acceleration range			Frequency of initiating event (1/year)	Core damage frequency (1/year)	Contribution (%)
Label	lower limit (g)	upper limit (g)			
SEIS1	0.07	0.10	$2.69 \cdot 10^{-3}$	$3.66 \cdot 10^{-8}$	0.08
SEIS2	0.10	0.15	$1.08 \cdot 10^{-3}$	$1.03 \cdot 10^{-6}$	2.39
SEIS3	0.15	0.22	$3.16 \cdot 10^{-4}$	$3.75 \cdot 10^{-6}$	8.69
SEIS4	0.22	0.32	$8.71 \cdot 10^{-5}$	$9.97 \cdot 10^{-6}$	23.14
SEIS5	0.32	0.48	$2.35 \cdot 10^{-5}$	$2.27 \cdot 10^{-5}$	52.57
SEIS6	0.48	0.70	$4.76 \cdot 10^{-6}$	$4.76 \cdot 10^{-6}$	11.03
SEIS7	0.70	1.00	$8.99 \cdot 10^{-7}$	$8.99 \cdot 10^{-7}$	2.09
Total:				$4.31 \cdot 10^{-5}$	100.00

The expected value of the annual core damage frequency from earthquakes occurring in a shutdown state is: $4.72 \cdot 10^{-6}$ /year, considering each shutdown service state and acceleration (seismic intensity) range.

It derives from the above statement that in the scope of the current analyses the calculated total core damage frequency is less than the target value of 10^{-4} /year recommended in the Hungarian regulations and in the international documents: the requirement is numerically met.

No system or component can be identified, which would significantly contribute to the core damage frequency, i.e. the risk components are acceptably balanced.

The numeric results show that out of the initiating events analyzed earthquakes are the events, and out of the errors analyzed human failures are the dominant contributors to core damage. In order to decrease these effects, corrective measures were implemented based on the PSA analyses well before the Fukushima accident. These measures included, among others, the extension of qualification scope of seismic reinforcements of electrical and instrumentation and control devices, and the development of further operator aids and instructions.

Except for earthquakes, the analysis of external hazards does not belong to the scope of the current PSA, but the respective assessment is in progress.

1.3.2.2. Results of the Level 2 PSA

The analyzed event sequences terminate with various damage states of the containment (final events). In order to characterize the radioactive releases, the source term from the containment the duration and location (release route) of containment damage and the availability of the most of all influencing sprinkler systems has been taken into account. Atmospheric release and release towards the soil and ground water have been distinguished among the releases. 13 source term classes have been set for atmospheric release from closed reactor and two source term classes for open reactor.

The magnitude of ^{137}Cs release, which is the most important isotope for the health effects, and the probabilistic parameters of the release have been determined by the calculations for each event sequence representing the dominant plant damage states. The results can be seen in Figure 1-14, while the symbols and names of the source term categories are summarized in Table 1-4.

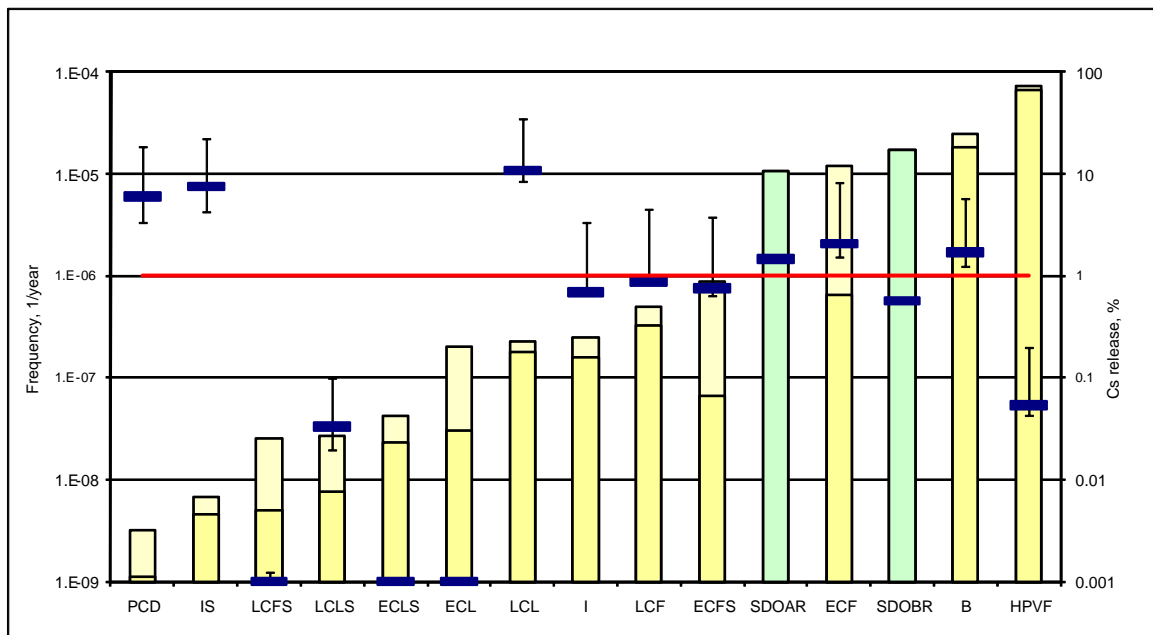

Figure 1-14: Source term categories and frequencies

(The columns show the maximum and minimum relative release for the categories, while the lines show the occurrence frequencies and uncertainty ranges)

Table 1-4: Source term categories

Source term category / containment state	
1	High pressure reactor pressure vessel rupture (HPVF/HPME)
2	Release bypassing the containment (by-pass) (B)
3	Early containment failure (ECF)
4	Early containment leakage increase (ECL)
5	Late containment failure (LCF)
6	Late containment leakage increase (LCL)
7	Early containment rupture with sprinkle (ECFS)
8	Early containment leakage increase with sprinkler (ECLS)
9	Late containment rupture with sprinkler (LCFS)
10	Late containment leakage increase with sprinkler (LCLS)
11	Intact containment (I)
12	Intact containment with sprinkler (IS)
13	Partial core damage (PCD)
14	Open containment, severe core damage before refuelling (SDOBR)
15	Open containment, severe core damage after refuelling (SDOAR)

The frequency of large radioactive release in the case of technological origin, internal fire or flooding events at normal power or shutdown reactor meets the usual target value of 10^{-5} /year according to the Hungarian regulation and international practice. Out of the accidents the frequency of the sequences leading to early containment rupture was higher than acceptable (due to the potential explosion of the hydrogen generated during severe fuel damage), therefore, in order to decrease the risk, still before the Fukushima accident, decision was made on application of hydrogen management procedure using passive autocatalytic recombiners, which solution was implemented on each of the units in the meantime.

In order to withhold the corium inside the vessel and thereby to avoid the melt through of the concrete basement by flooding the reactor cavity an accident management procedure applying external reactor vessel cooling procedure was developed and the respective modifications are implemented according to the schedule of Table 1-2.

Procedures to prevent and mitigate the consequences of potential accidents in shutdown state at open reactor are in the phase of development.

The PSA results described do not include the impact of severe accident management procedures and modifications at Paks NPP. The concept for the severe accident management modifications that are currently in the phase of implementation, has been determined in such a way that the proposed measures significantly decrease the extent of release in the case of the relatively large frequency sequences leading to significant radioactive release (SD, ECF and B) or the frequency of the most dangerous categories. It is obvious therefore that the Level 2 PSA taking account of the modifications will show even better results.

1.3.2.3. Results of spent fuel pool PSA analysis

Level 1 PSA analyses performed for the spent fuel pools have quantified the frequency of damage of the spent fuel and its contributors, and determined the uncertainties of the results. Out of the initiating events the internal, technology origin failures and the risks from internal fire and flooding have been analyzed. The results are described on the example of Unit 2 again.

By assessing the contributions of the initiating event groups, the results show that the most important sequences from the aspect of damage of the spent fuel are those starting with loss of coolant at excludable location (49.1%). Fire events also have important contribution (28.8%). Loss of cooling (15.3%) and loss of coolant at non excludable location (6.7%) have significantly less but not negligible importance.

The objective of Level 2 PSA of the spent fuel pool is to determine the extent of radioactive release from fuel damage, the respective frequency and to develop the accident management measures. Scope of the analysis is identical to that of the Level 1 analysis.

A single source term category was used to describe the loss of coolant and loss of cooling accident situations of the spent fuel pool and it was assumed that the fuel damage also means large release. The frequency of that is $8.2 \cdot 10^{-7}$ /year, calculated for unit 2.

Although the results can be accepted regarding the calculated level of risk, due to the direct connection of the pool to the reactor hall, further modifications have been initiated and are implemented to prevent severe accidents. These cover increase of reliability of the cooling of the fuel assemblies, as safety function.

1.3.2.4. Regular update of PSA analyses

In addition to the implementation and gradual extension of the baseline PSA analyses update of the former analyses are carried out every year.

The safety improvement programme accomplished in 2002 significantly improved the safety of Paks NPP. Such modifications were implemented that:

- decreased the loads of the equipment (e.g. mitigation of the risk of pressurized thermal shock of the reactor pressure vessel),
- improved the reliability of safety systems (electric supply, increase of fire safety, provision of diversity of protections, relocation of auxiliary emergency feedwater system of steam generators to protected place), and
- improved the management of transients (management of steam generator collector lift-off, termination of artificial de-voltage procedure).

As the result of the safety improvement measures the core damage frequency of the units has been significantly decreased in the recent years. This is illustrated in Figure 1-15 on the example of Unit 2 for internal events at normal power.

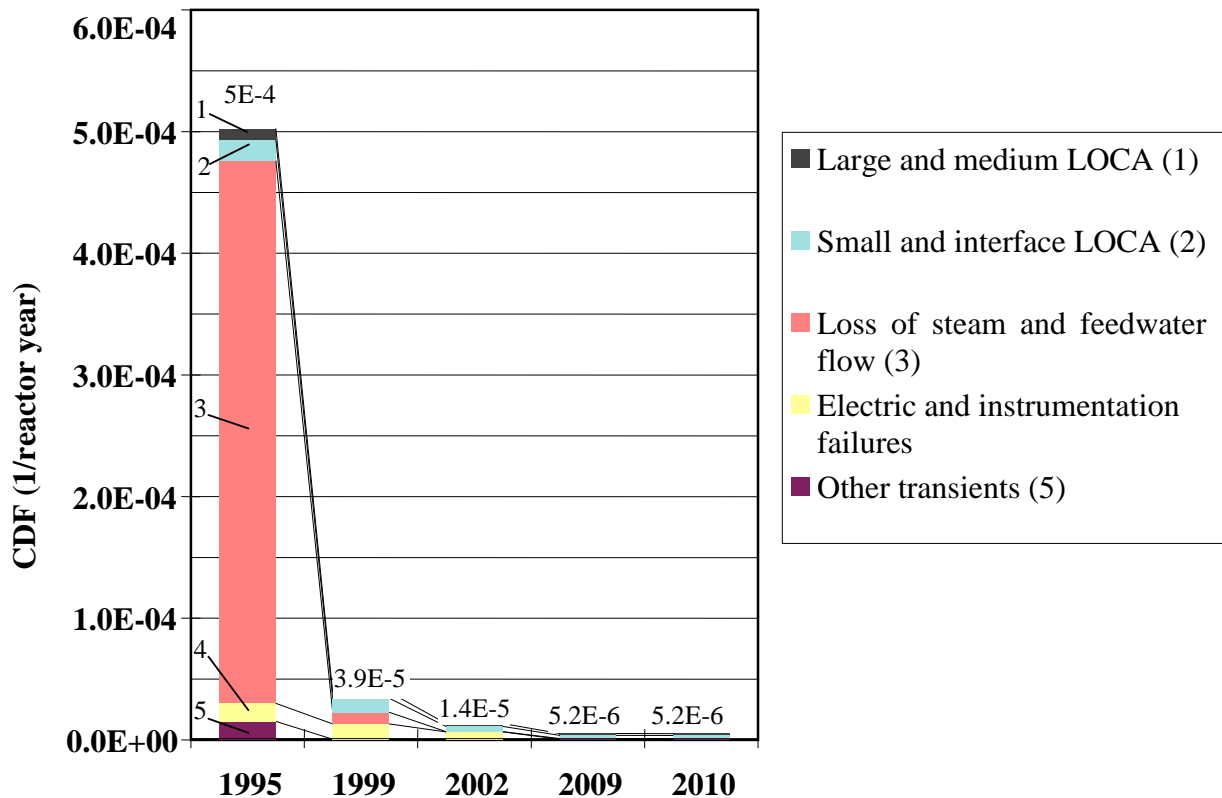

Figure 1-15: Evolution of core damage frequency between 1995 and 2010, Unit 2

2. Earthquakes

2.1. Design basis

2.1.1. Earthquake against which the plant is designed

The site of the NPP was selected according to the industrial siting practice of the 60s'. The technical design started at the beginning of the 70s', which required the investigation and evaluation of the geological and seismological conditions of the site according to the Soviet practice of that era. Seismicity of the site was determined based on historical and instrumental earthquake records and it was characterized by 5 balls on the MSK-64 macro-seismic intensity scale. The design basis intensity, i.e. the intensity of the so-called maximum design earthquake of the design basis was taken 1 intensity degree higher and standard acceleration values were assigned thereto, which resulted in 0.025-0.05 g.

Comprehensive geological assessment of the Paks site, including the determination of design basis earthquake for the site began in 1986. Evaluation of seismic hazards and the design basis earthquake (safe shutdown earthquake, SSE) was completed in 1996. The work was supported by the „Regional Programme for Nuclear Safety 4.2.1 VVER 440-213 Seismic Hazard Re-evaluation” PHARE project of the European Commission and by the technical cooperation projects and review missions of the IAEA.

The site survey, qualification and determination of design basis earthquake between 1986 and 1996 followed the international practice and the IAEA standards of that time. Field and laboratory measurements complied with the IAEA standards 50-SG-S8 and 50-SG-S9 and the respective industrial standards and practice, while evaluation of seismic hazards took place according to the IAEA guidelines 50-SG-S1 and 50-SG-S2 and international practice, using probabilistic methods (PSHA).

Based on the results of the seismic hazard analysis, the peak ground acceleration of the design basis earthquake has been set to 0.25 g for the horizontal and 0.2 g for the vertical components. The free-field acceleration values and the free-field response spectra were calculated by taking into account the soft soil conditions covering the surface. Hereinafter this earthquake is called design basis earthquake.

During the Periodic Safety Reviews (1999 and 2007) the analysis of the site seismic hazard has been reviewed and updated in light of the new scientific evidences and data obtained by micro-seismic monitoring system as well as the recent stress and movement measurements. The development of the state-of-the-art and international standards has been taken into account while performing the Periodic Safety Reviews (we refer mainly to the IAEA safety standards NS-R-3 and the respective Safety Guides, and also SSG-9).

2.1.1.1. Methodology used to evaluate the design basis earthquake

Due to the geological and seismological circumstances, the seismic hazards of the site were determined using probabilistic methodology. The mains steps of the methodology were:

- identification and characterization of earthquake source-zone models (magnitude-frequency distributions and cut-off magnitudes),
- selection of attenuation laws,
- calculation of the hazard curve using a logical tree (probabilistic method),
- calculation of the response spectra for the bedrock (Pannonian surface),
- calculation of free-field response spectra taking into account the non-linear transfer through the young sedimentary soil covering the Pannonian surface.

The assessments above were supplemented with the analysis of the possibility of soil liquefaction and permanent surface displacement.

In compliance with the IAEA 50-SG-S1, the development of the geological structural model took into account the geological, geomechanical, geophysical, stratigraphic, hydrogeological data, assessments of the geological evolution and tectonics, seismicity of the region including the historical, instrumental records and the data of the micro-seismic monitoring.

The area subjected to detailed review covered a territory of a radius of >300 km around the site. This is shown in Figure 2-1 that displays one of the earthquake source models considered in the review. The total source area considered in the review was divided into source zones, in all of which homogenous seismicity was assumed. Seismic activity and earthquake frequency parameters were determined for each zone.

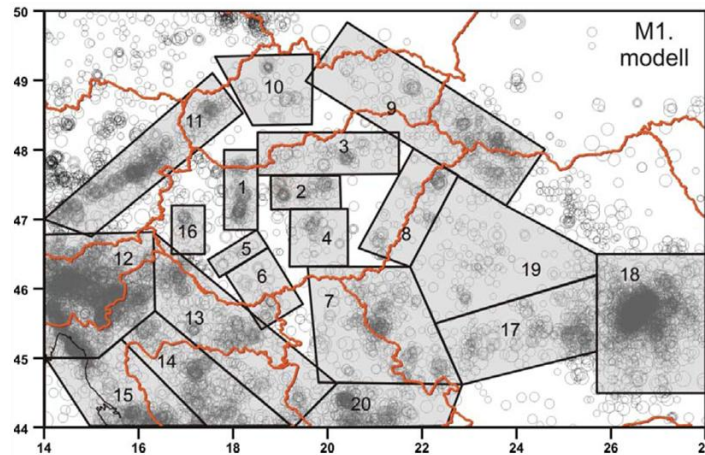

Figure 2-1: One of the earthquake zone models with the earthquake epicentres

The regional assessment of the distant areas served for better understanding and outline of the regional geodynamics picture. In addition to the set of geological borings, the assessment of the site geological features included seismic and shallow seismic profiling, georadar examinations and detailed geotechnical survey.

The current Hungarian regulation takes the 0.005 non-exceedance probability earthquake as design basis for the whole life span of the plant, the parameters of which (peak ground acceleration - PGA, response spectrum) shall be determined based on the median hazard curve by taking into account the effect of the sediment covering the surface. The regulation requires avoidance of the cliff-edge effect while defining the design base earthquake spectra. Notwithstanding the design basis of Paks NPP was specified more conservatively, on the 10^{-4} /year exceedance level using the weighted mean hazard curve. Figure 2-2 shows the mean, weighted mean and different quantiles of the hazard curve.

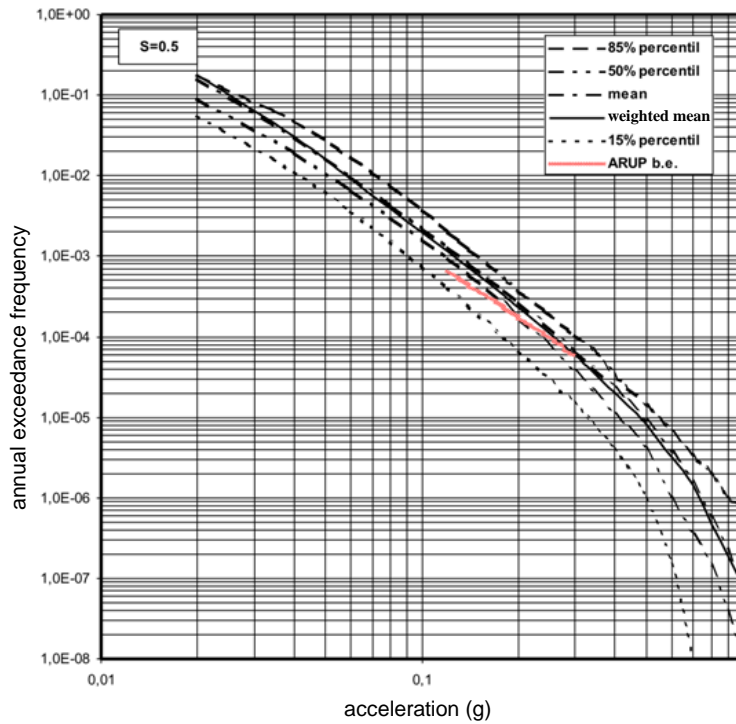

Figure 2-2: Seismic hazard curve

The uniform hazard response spectra of the earthquake of 10^{-4} /year exceedance frequency were determined for the Pannonian surface, as for outcrop. Figure 2-3 shows the response spectra calculated for rock outcrop and free-field surface acceleration.

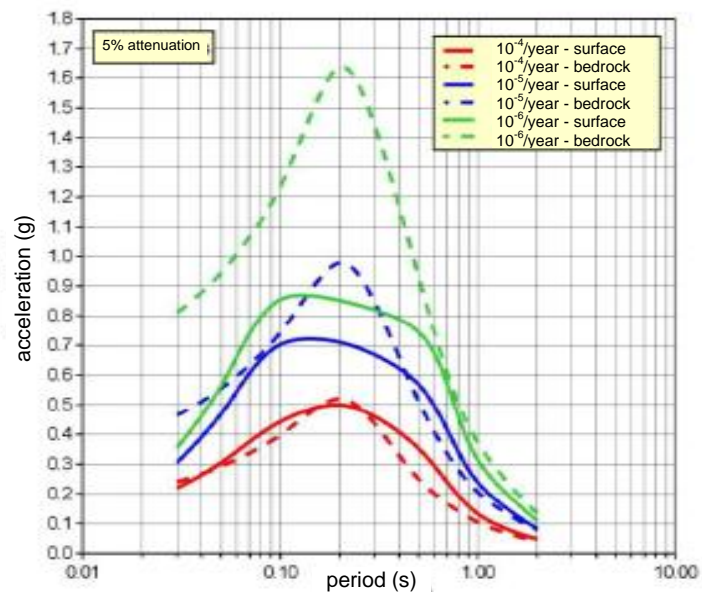

Figure 2-3: Uniform hazard response spectra of ground acceleration for various non-exceedance frequencies

The result was compared to the response spectra pertaining to 84% confidence level determined by using deterministic methods.

The free-field response spectra taken as design basis were calculated from the uniform hazard response spectrum taking into account the nonlinear transfer through the young soft sediment covering the site. The free-field response spectra have been selected for design basis. The adequacy of this design basis has been verified during the Periodic Safety Review according to US NRC Regulatory Guide 1.208 and ASCE/SEI 43-05 standard. It was determined that in order to take into

account the spectral amplitude variation entailing small change of exceedance probability it is not practically necessary to modify the response spectrum taken as basis for design. So cliff-edge effect is excluded from the aspect of design input.

2.1.1.2. Analysis of the possibility of capable faulting

The pre-Neogen substratum in the vicinity of the plant is at the depth of 1600-1700 m. According to our knowledge so far, the deep basin basement is composed of granited metamorphic formation and muscovite-biotite gneiss. The series of more than 1000 m thick lacustrine, deltaic and fluvial sediments from Late Miocene–Pliocene and Pannonian Lake covers the basic mountain.

The lower part of the Pannonian formations (12 million years old) is of sediment layers, altogether in 100-150 m thickness. The thickness of the upper Pannonian formation group is >500 m in the territory. The age of the upper Pannonian formations is 5-6 million years. The eroded (~6 million years old) upper Pannonian surface below the site is overlain by a very young soft alluvial sedimentation.

The lower part of the Pannonian formations (12 million years old) is of sediment layers, altogether in 100-150 m thickness. The thickness of the upper Pannonian formation group is >500 m in the territory. The age of the upper Pannonian formations is 5-6 million years. The eroded (~6 million years old) upper Pannonian surface below the site is overlain by a very young soft alluvial sedimentation.

The basic issue of the complex geological survey of the site was whether the structures around the site have been active during the current tectonic regime (2.5 million year) or, in other words, whether the several fault lines in the Pannonian layer seen in the seismic profiles in the vicinity of the site have been active during the Quaternary Period.

The detailed geological survey and geophysical profiling performed in the vicinity of the site showed that there is no obvious sign of Quaternary faults, the faults existing in the Pannonian layers have not penetrated into the upper Quaternary layer, which is at least 45 thousand years old. At larger distance from the site, where data could be obtained, the Quaternary sediment is not disturbed.

Thus, according to the evaluation of direct and indirect data performed by Hungarian and international experts, there is no geological and geomorphologic evidence on the activity of the faults located in the vicinity of the site. In conclusion, the structures existing in the Pannonian layers in the vicinity of the site are not active with high probability and, consequently, with very high probability, they do not cause permanent surface deformation.

2.1.1.3. Evaluation of soil liquefaction hazard

The possibility of occurrence of soil liquefaction cannot be excluded based on the assessment of the soil characteristics of the site. On the basis of assessments with simple empiric or semi-empiric methods, the safety margin against soil liquefaction for pore water pressure causing the liquefaction in the layers between 10 and 20 m is only approximately 1.1 with conservative calculations.

The possibility of occurrence of soil liquefaction cannot be excluded a priori due to the soil characteristics at the site. Conservative empiric methods provides low, approximately 1.1 margin against soil liquefaction in the layers between 10 and 20 m beneath the site.

According to the calculations performed with probabilistic methods, considering the soil-building interaction that modifies the cyclic shearing stress, the recurrence time of soil liquefaction in the soil layers loaded by the main building is 14,000-18,000 years. It means that this phenomenon can be excluded from the design basis. This result was basically supported also by the calculation using the effective stress method.

2.1.1.4. Conclusion on the adequacy of the design basis for the earthquake

The seismic hazard of the Paks NPP site has been assessed according to the Hungarian requirements, in line with international standards and good practice.

The data and knowledge-base obtained during the site investigation and used for hazard evaluation, has been supplemented and updated during the periodic safety reviews with new scientific results on neotectonics and seismology and data obtained from micro-seismic monitoring operated since 1995 and results from geophysical and geotechnical examinations.

Micro-seismic monitoring is considered as one of the most adequate indicators on seismic activity, especially on the activity of the structures assumed in the vicinity of the site.

Seismological evaluation of the results of the 10 years' monitoring was completed in 2005 together with the revision of the neotectonics model.

As the result of monitoring, the reliability of the input data of hazard calculations regarding the frequency of earthquakes has been significantly improved.

The information obtained from micro-seismic monitoring in the last 16 years demonstrates that the activity of the structures around the NPP (within a distance of 10 km) is negligible, though the amount of measurement data is relatively small due to the moderate seismicity. On the basis of the events registered it can be stated that most of the recent earthquakes are correlated with the distant sources formerly identified. Considering the detection capabilities of the measurement network around the Paks site, it can be established with high confidence that there were no such earthquake in the 50 km environment of the Paks NPP during the monitoring period, which would require revisiting of the former conservative assumptions regarding seismic activity.

In relation to the pore water pressure typical for soil liquefaction, by using detailed stress calculation methods, the margins are obtained to be larger compared to that described above, since the non-linear effect has been stronger in the range of larger quakes. Evaluation of the behaviour of the safety-classified buildings of the NPP for the case of soil liquefaction concluded that soil liquefaction does not lead to loss of stability, but may cause the settlement of the buildings. Investigations are currently going on to more accurately assess the potential building settlement after an earthquake.

2.1.2. Provisions to protect the plants against the design basis earthquake

Seismic hazards have been underestimated in the siting and design of Paks NPP as it is described in Section 2.1.1. Due to that and in line with the Soviet norms and standards of that era and the NPP has not been designed to withstand any earthquake loads and the active components have not been subjected to seismic qualification.

The objective of the seismic-safety program launched in 1993 was to qualify the Paks NPP from structural (pressure retention and load bearing), system point of view for the newly defined design basis earthquake. A graded approach according to safety was used for that purpose combining the methods and allowances applied during design procedures of NPPs and methods developed for review and re-qualification of operating NPPs.

As for initial condition, normal power operation has been assumed in the safety analyses. The rupture of the main circulation loop reinforced for earthquakes has not been considered, and it was assumed that the external electric power and demineralised water supply and off-site fuel supply for the emergency diesel generators is not available for 72 hours.

The most important reviews, reinforcement and qualification measures implemented between 1993 and 2003 were as follows:

- all systems, structures and components of the NPP, the structural integrity or operability of which is required for ensuring the basic safety functions during and after an earthquake have been identified and classified into seismic safety classes, and also those non safety systems,

structures and components have been identified, which might jeopardize the fulfilment of a safety function by their failure (fall-down, fire, flooding etc.),

- seismic safety evaluation (structural integrity, performance of active functions) of the NPP was performed for the newly defined (1996) design basis essentially following the design basis requirements; the necessary reinforcements were designed and implemented and the active system components were qualified,
- pre-earthquake procedures and instructions have been developed for the operators, and the respective seismic instrumentation was installed,
- procedures were introduced for appropriate operational housekeeping and to ensure the observation of seismic safety requirements during purchases and modifications.

The main tasks were implemented as described below:

- Seismic endurance of the primary cooling circuit components was assessed and they were reinforced with viscous snubbers. By this step the avoidance of primary circuit ruptures due to a design basis earthquake was ensured. Figure 2-4 shows a typical reinforcement location.
- Beyond the assessment and the qualification and necessary reinforcement of the primary reactor cooling circuit components for the design basis earthquake, also the emergency core cooling systems and the active pressure relief system of the hermetic compartments were qualified for earthquakes. Consequently if, despite the reinforcements, a loss of coolant accident takes place after an earthquake, the main safety functions can be maintained. In this case, the operators would follow the emergency operating procedures to be applied for loss of coolant cases. Although the procedures are not optimal, but still effective.
- Reactor shutdown, cool-down, and long term cooling are performed with the same original operational and safety system and essentially in the same way as during any other normal or emergency shutdown situations.

Reactivity control is performed by the safety and control system and by injecting boric acid to the space above the core by the high pressure emergency core cooling pumps through the venting of the reactor head.

Initially, the removal of decay heat is performed with the secondary steam blow-down system into the atmosphere or by the opening of safety valves of the steam generators and injection of demineralised water, if necessary. Later, in the lower temperature range, the normal operational cool-down system removes the residual heat. Each component of the cooling technology was qualified and reinforced if necessary.

Cooling down and borating should be performed during natural circulation of the primary coolant. Systems required for this function were qualified for the design basis earthquake and reinforced if necessary.



Figure 2-4: Reinforcement by viscous snubbers

- It was demonstrated through shaking table testing of the safety and control assemblies that they would not lose their functionality even if a load much larger than that caused by the design basis earthquake would occur in the reactor; hence, shutdown can be ensured during or after the earthquake.
- The preconditions for shutdown, cool-down and long term cooling of the reactor and for cooling of the spent fuel pool after an earthquake are: the availability of safety power supply and the operability of the essential service water systems. Their qualifications and necessary reinforcements were also implemented.
- An appropriate instrumentation and alarm system serves for the automatic isolation of the non-safety related and not reinforced systems for supporting the control of criteria of the safe operation and the plant status.
- No automatic emergency reactor shutdown function is installed for exceeding a pre-set acceleration level. The reason is that an unjustified/spurious shutdown and disconnection of all of the four units from the electric power grid at the same time may have more severe safety consequences than a somewhat delayed shutdown of the reactors due to any abnormal technological signal or damage caused by the earthquake.
- All seismic safety measures were implemented that can avoid or limit the secondary effects of an earthquake, e.g. fires, flooding and other interactions (the measures comprised the implementation of the emergency discharge of generator hydrogen and shaft sealing oil, reinforcement of the fire extinguishing systems and systems containing fire hazardous materials).
- The necessary parts of the fire water system of the NPP were fixed to provide their independence of the not reinforced external loops and to provide the water supply for the internal circuit of the fire protection system. The Diesel-engine-driven fire water pumps providing fire water have designed for earthquake.
- Buildings and building structures were also reinforced as a result of the seismic assessment. Among others:
 - Main buildings of Units 1-4,
 - Turbine hall podiums of Units 1-4,
 - Brick walls of Units 1-4 near electrical equipment,
 - “B” row masonry wall of the turbine halls of Units 1-4 between levels of +24 m and +33 m,
 - main control room suspended ceilings,
 - emergency diesel engine buildings,
 - auxiliary buildings,
 - building of water intake control,
 - control building of demineralised water.
- Low and medium activity liquid radioactive waste tanks are not reinforced, since the rooms of the tanks are equipped with recovery system and the release calculations assuming tank damage did not justify the need of reinforcement.
- As part of the seismic upgrading programme, the integrity of the spent fuel pool was also evaluated. It was demonstrated by analysis that the reinforced concrete block of the reactor building preserves its structural integrity for the seismic loads of a design basis earthquake, which also means that the integrity of the spent fuel pool, which is part of the reinforced concrete block, is ensured. No additional reinforcement was necessary in this case. Damage of the roof structure above the pools in the reactor building caused by the earthquake would mean danger to the fuel elements stored in the spent fuel pool. Seismic protection of the reactor hall was assessed and such reinforcements were implemented which provide the integrity of the reactor hall and falling down of roof panels can be avoided. Stability of the parking position of the refuelling and hoisting machines above the open spent fuel pool were

assessed, and it was concluded that falling down of these machines need not be assumed. Probability of earthquakes during displacement of the relatively rarely used hoisting machines is significantly lower; the contribution of such cases to the overall risk was evaluated in the probabilistic safety assessments.

- Those elements of the spent fuel and refuelling pools, which ensure continuous circulation of the coolant or are necessary to avoid loss of coolant, were qualified and reinforced, if it was necessary.

A formerly implemented review revealed dangers in the reactor and turbine halls and in the control rooms potentially caused by auxiliary equipment, should an earthquake occur. The measures required to survey the equipment causing potential dangers and to terminate the danger were implemented. Measures and reinforcements providing the stability of certain auxiliary equipment were also performed.

The review pointed out that during main outages the practical implementation of the principle of safety-conscious operations does not fully consider the aspects of seismic safety, therefore, in order to continuously maintain the seismic safety level of the plant, periodic inspection of the rooms and compartment has to be performed, where temporary storage of some equipment or structures used e.g. during the maintenance does not comply with seismic safety requirements and may cause potential hazard.

A special emergency procedure regulates the operators' activity in response to earthquakes. The procedure defines the inspections and walk-down necessary for condition survey after the earthquake. The number of operating personnel was determined to be able to carry out the interventions in response to the earthquake (design basis earthquake affecting all four units).

The units withstand the earthquakes below the level of design basis earthquake without significant radioactive release. At the same time, damages, like fires, etc. might occur on the site in consequence of the earthquake in the conventional portions of the plant not reinforced for earthquakes. In the case of cable and oil fires, floods or other extraordinary situations occurring in consequence of the earthquake, the plant fire brigade is the first responder organization equipped with modern tools and necessary resources.

An earthquake may impede the accessibility of the plant or certain settlements, which may make the shift changes temporarily impossible. Organization of shift changes starts in the early period after the occurrence of the event. It is a favourable circumstance that majority of the operating personnel lives in settlements in the vicinity of the plant (within 5-10 km) in various directions. In addition, a preparedness system is operated. The personnel on the site may rest in the shelter for 300 persons and in the dual function shelter for 450 persons.

The tools of internal and external communication are the wired telecommunication and, in design basis situations, the high frequency radio system. Routes of the wired telecommunication are not qualified for earthquake. The antenna tower of the radio system has no seismic qualification. If the antenna tower would be damaged in consequence of an earthquake, the radio system would be able to transmit within a limited operational range (max. 1-3 km depending on field conditions).

Review of design basis seismic safety pointed out some indirect effects of the earthquake, by the elimination of which the level of safety can be improved:

1. The demineralised water storage tanks, with supplementary anchorage, can withstand the direct loads of design basis earthquakes. However, the three common tanks of Installation II (e.g. Units 3 and 4) are situated in the direct vicinity of the service building, which is a reinforced concrete structure building of significant robustness, but formally is not qualified for design basis earthquakes. The tanks therefore are not protected against the falling down of panels from the building (Figure 2-5) if the building would tilt to the side and not the most probable damage (collapse) would take place. The fact that in an earthquake of larger intensity, one of the tanks that back up each other, would damage were taken into account in the seismic PSA.



Figure 2-5: Demineralised water tanks of Installation II next to the wall of the service building

2. Since the loss of the service building cannot be totally excluded, also the personal dosimeters stored there may loss and change to protective cloths will also be more difficult. The usability of the building therefore has logistic importance.
3. The building in Figure 2-6 used for staying place of the plant fire brigade is not qualified for earthquake. The well-designed barrack building is made of reinforced concrete. The protection of the personnel and the equipment in this building can be ensured with minor measures.



Figure 2-6: Fire brigade barrack on the NPP site

4. The main condenser cooling water system has no function during and after an earthquake, thus the components of the system and its steel pipelines of 3600 mm in diameter, placed in a trench (Figure 2-7) are not formally qualified for earthquake. The potential damage of the pipeline therefore cannot be excluded even for the events less than design basis earthquake. The pipelines contain significant volume of water. If it is discharged, it fills up the pipeline trenches. Theoretically there is enough space available to accommodate the discharged amount of water, but the extent of flooding and other effects need further investigations for the case of the main condenser cooling water pumps not being stopped by chance. In this case, the uniform filling up of the trenches is not guaranteed, local flooding might occur. Depending on the location of damage, flooding of the safety cable tunnels towards the emergency diesel generator and water intake buildings, the cellar level of the water intake building containing safety cable junctions and of the cellar level of the turbine hall might be also possible. It is desirable to investigate the consequences from the rupture of large diameter pipeline and to increase the protection against such an event, if it is necessary.



Figure 2-7: Courtyard pipelines of the main condenser cooling water system

5. Measures are required to fix the full scope of maintenance tools and equipment stored at the units after the outages, which may jeopardize the technological equipment.
6. Out of the shelters only the largest one, suitable for 450 persons and used as Protected Command Centre has seismic qualification. Part of the equipment in the shelters was installed in an earthquake proof manner. The qualification of the other shelters and the fixing of the equipment inside have to be improved.
7. Difficulties might occur in the internal and external communications in the function of the intensity of the earthquake, since the routes of the wired communication lines do not have seismic qualification. In the design basis situations the VHF radio system is the basic communication opportunity within the 30 km territory radius around the NPP. However, the antenna tower of the radio system is not qualified for earthquakes; if it is damaged as a consequence of an earthquake, then the radio sets may communicate in limited range only (maximum 1-3 km depending on the surface and building conditions).
8. Seismic qualification of the filtration units (machine racks and travelling water band screens) for screening the centimetre and millimetre large pieces at the essential service water pumps was not part of the former scope. Although these are robust structures, further investigation are needed and, if necessary, measures to be implemented for avoiding the clogging after an earthquake, which may endanger the fulfilment of ultimate heat sink function in long-term.

2.1.3. Compliance of the plant with its current licensing basis

By implementing the measures presented above Paks NPP complies with the seismic safety requirements.

There are appropriate internal procedures for maintaining the seismically qualified conditions during modifications, purchases, reconstructions, repairs and maintenance and for restoring the seismic fixes after outages. Procedures are also in place to maintain the seismic housekeeping. The Periodic Safety Reviews and the system of feedback and evaluation of operational experiences ensure the maintenance of the due conditions.

Earthquake instrumentation, the fast operation valves to detach the seismically reinforced systems from the non reinforced one, automatic actuations to prevent fires after earthquakes in systems containing flammable materials (like hydrogen) and the fire extinguisher systems are regularly tested according to the respective procedures and manuals.

Mobile equipment and reserves to implement the post-earthquake measures are available, their storage, periodic inspection and operation is properly regulated. After an earthquake of the design basis or beyond design basis level the Emergency Response Organization (ERO) staff of the NPP

activates. The documents regulating the activity of the ERO contains the detailed rules of use of the mobile equipment and reserves available.

Concerning the potential post-earthquake cable and oil fires, flooding or other extraordinary situations at the parts not qualified for earthquake, the personnel of the plant fire brigade equipped with modern equipment and necessary resources have the intervention plans and they are trained for performing these functions.

It is required by law to review the site characteristics (assessment and evaluation of actual status) every 10 years in the frame of the Periodic Safety Review (PSR). Such a review took place in 2007 in the frame of the last PSR.

The authority review of the last PSR report pointed out that in the case of certain components (demineralised water, essential service water, etc.) the design basis given in the seismic safety licensing documentation do not completely comply with the information contained in the plant's database of seismic safety classification of the components.

2.2. Evaluation of safety margins

2.2.1. Range of earthquakes leading to severe fuel damage

2.2.1.1. Evaluation of soil liquefaction hazard

Under the upper soil layer, there is Pleistocene layer of 25-30 m, the upper 12-15 part of the alluvium consists of fine structure, well classified sand, while its lower part consist of sandy gravel and gravel, gravel-scattered sand. Under the Pleistocene sediment, there are layers of lacustrine origin, variously developed upper Pannonian layers, which are irregularly divided by sandstone ridges. These ridges are cemented to various extents and can be regarded as semi-rocks.

Three typical layers can be identified on the site from geotechnical point of view:

Type 1: Quaternary period fluvial/Aeolian sediments (including alluvium): density of 1900 kg/m³,

Type 2: Quaternary period fluvial sand and gravel: density of 2000 kg/m³,

Type 3: Quaternary period fluvial gravel: density of 2100 kg/m³.

These layers cover the Pannonian layer, which can be characterized by a shear-wave velocity higher than 500 m/s, a density of 2100 kg/m³ and a shearing modulus of 525 MPa.

According to Section 2.1.1 soil liquefaction needs not be considered in the design basis, but its occurrence cannot be excluded based on the soil characteristics described above. On the basis of assessments with simple empiric or semi-empiric methods, the safety margin against soil liquefaction in the layers between 10 and 20 m is approximately 1.1 only with conservative calculations. Using detailed stress calculation methods in the most recent studies, the margins are obtained to be larger, since the non-linear effect is stronger in the range of larger quakes.

Due to the assumptions accepted in the seismic PSA, the safety margin against extent soil liquefaction is not large for design basis earthquakes. According to seismic PSA the HCLPF² of the liquefaction (i.e. the probability of exceedance is less then 5% at 95% confidence level) is 0.2 g while the PGA is taken on the Pannonia surface (conditional outcrop). In this case, HCLPF value is not less than 0.25 g when the horizontal free-field peak-ground acceleration considered. This is even more expressed when the spectral amplification for lower frequencies is considered, since in

²A certain value of HCLPF (High-Confidence-of-Low-Probability-of-Failure) expressed in terms of peak-ground acceleration means that the probability of failure is less than 5% with 95% of confidence in case of an earthquake with given peak-ground acceleration.

the case of design basis earthquake, the spectral amplification reaches 1.3 at 1 Hz as shown in Figure 2-3.

Nevertheless, the dominating damage mode in the acceleration ranges beyond design basis is the soil liquefaction, as shown in Figures 2-8 and 2-9. This makes necessary the re-qualification of the underground lines and connections, which may be jeopardized by the settlement of the main building or, if it is necessary, to modify them to make their relative displacement possible.

2.2.1.2. Vulnerability of electric power supply function in case of earthquake

The electric power supply may be lost due to the concurrent occurrence of the following two events:

- loss of normal electric power supply,
- loss of emergency diesel generators as the designed backup electric power supply after the normal electric power supply is lost.

Long term loss of electric power supply in the seismic PSA means that the possible intervention aimed at recovering this function or using any other alternative supply means is not taken into account.

Damages identified in the seismic PSA assessment that cause the loss of normal electric supply are as follows:

- Loss of off-site grid due to earthquake;
- Soil liquefaction that jeopardizes the equipment of the open-air transformer station and consequently causes the loss of external grid;
- Soil liquefaction that causes island-like settlement of the main building, which causes damages to the systems connected from outside to the main building (such as underground pipelines and electric cabling);
- Concurrent damage of the electric and instrumentation components characterized by lower threshold value³, such as certain circuit breakers and relays required for continuous operation of the 6 kV bus-bars of normal electric supply;
- Damage of the building complex (reactor hall, longitudinal electric gallery and turbine hall), which causes the loss of normal electric power supply through the loss of external connections on the one hand, and through the loss of electric grid inside the building complex on the other hand;
- Damage of the transversal electric gallery, which causes damage to the 6 kV distributors;
- Concurrent damage of the components characterized by upper threshold value⁴. These include, among others, the main elements of normal electric power supply, such as the electric distributors themselves.

Damages identified in the seismic PSA assessment that cause loss off electric supply by the emergency diesel generators:

³ Group of those system components, about which it was conceivable based on the earthquake experiences and seismic tests that the probability of their damage up to a given, appropriately high load value is negligible, practically excludable. In the case of the loads higher than this threshold value, which is a lower screening load for the total group, the damages of component in the group are conservatively regarded as fully correlating (simultaneously occurring) events during the assessment.

⁴ Group of those system components, about which it was conceivable based on the earthquake experiences and seismic tests that the probability of their damage up to a given, appropriately high load value is negligible, practically excludable. In the case of the loads higher than this threshold value, which is an upper screening load for the total group, the seismic damages in the group are conservatively regarded as fully correlating (simultaneously occurring) events during the assessment.

- Soil liquefaction that causes island-like settlement of the main building, which causes damages to the systems connected from outside to the main building (such as supply line from the emergency diesel generators);
- Concurrent damage of the electric and instrumentation components characterized by lower threshold value, such as certain circuit breakers and relays required for operation of the emergency diesel generators and their auxiliary systems;
- Damage of certain supporting structures of the emergency diesel generators, which causes direct inoperability of the emergency diesel generators;
- Concurrent damage of the mechanical components and structures characterized by lower threshold value, such as brick walls of emergency diesel generator machinery rooms, the collapse of which causes direct damage to the emergency diesel generators and their auxiliary systems;
- Concurrent damage of the components characterized by upper threshold value, such as significant portion of the mechanical components of the emergency diesel generators and their auxiliary systems;
- Damage of the water intake control building causes indirect inoperability of emergency diesel generators through causing the loss of essential service water system necessary for the operation of the emergency diesel generators;
- Damage of the main building complex (reactor hall, longitudinal electric gallery and turbine hall), causes indirectly the inoperability of the emergency diesel generators through damaging the pipelines and therefore causing the failure of the essential service water system necessary for the operation of the emergency diesel generators. emergency diesel generators for Installation II (unit 3 and 4) also receives electric power supply from the main building complex to their operation and the loss of this supply due to building damage also causes damage to the emergency diesel generators for these units;
- Damage of the water intake structure also causes indirectly the inoperability of the emergency diesel generators through the loss of essential service water necessary for the operation of the emergency diesel generators;
- Damage of the essential service water tanks also causes indirectly the inoperability of the emergency diesel generators, since in the case of loss of normal electric power supply the cooling water flow is not provided for start-up of the emergency diesel generators.

By considering all of the damage combinations leading to the loss of electric power supply and the relevant seismic vulnerabilities the probability of loss of electric power supply, i.e. the resultant seismic vulnerability was determined.

Probability of loss of electric power supply as final state is shown in Figure 2-8 as function of the load expressed in terms of ground acceleration related to Pannonian surface. In the seismic PSA For the determination of HCLPF in terms of free-field PGA an amplification value of 1.09 between Pannonian surface and free-field has been conservatively taken, although the realistic amplification is higher than this; see Figure 2-3 and the section “Evaluation of soil liquefaction hazard”. In the case of beyond design basis earthquakes the occurrence of the final state is not at all certain. The mean probability of occurrence reaches the value of 0.5 at 0.46 g acceleration, which acceleration is typical for an earthquake of an occurrence frequency of only 10^{-5} /year, which is significantly less than the design basis.

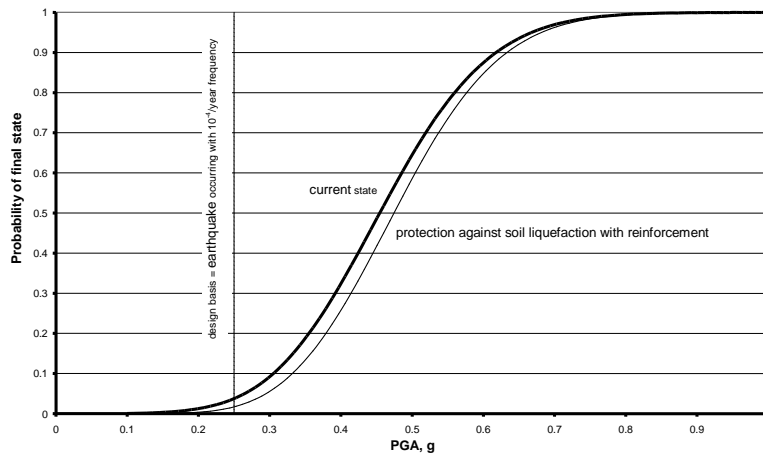

Figure 2-8: Mean probability of loss of electric power supply due to earthquake as function of peak ground acceleration (PGA) related to Pannonian surface

In the lower acceleration ranges the soil liquefaction that cause settlement of the main building plays dominant role in the occurrence probability of total loss of electric power supply. The reason is that soil liquefaction might concurrently lead to loss of normal electric supply and loss of emergency diesel generator supply.

If, by reinforcement, it would be successful to improve the characteristics of seismic damage state caused by settlement of the main building due to soil liquefaction to the vulnerability of mechanical components and structures characterized by the lower threshold value (0.27 g), then the mean vulnerability curve for the loss of electric supply would modify as marked with the light line. It is observable that in the case of earthquakes slightly exceeding the design basis earthquake the margins would increase significantly, for example for 0.3 g acceleration the mean probability of occurrence of the final state changes from 0.09 to 0.05.

From the aspect of damages causing the loss of electric power supply the reactor and the spent fuel pool are not different from each other; the loss of electric power supply affects simultaneously the reactor and the spent fuel pool. The probability of long term loss of electric power supply and the margin against beyond design basis earthquakes do not depend on the operation state of the reactor or the spent fuel pool. Consequently, the beyond design basis margin can be considered equal for both operation states.

The 400 kV and 120 kV substations are not safety systems and they have no functions in the case of design basis earthquakes. These substations, however, might provide many alternative electric supply opportunities for the units, if they are not damaged. It is also a significant advantage during a post-earthquake recovery phase, if the substations are applicable to receive external supply. After a significant earthquake the intactness of the substation is also necessary for the recovery of the national electric grid. Therefore upgrading of the seismic resistance of the substations and the automatisms switching the plant to isolated operation is reasonable.

2.2.1.3. Vulnerability of ultimate heat sink in case of earthquake

Loss of ultimate heat sink of the reactor occurs if heat removal through both the steam generators and the emergency core cooling system heat exchangers become impossible. There is a common part of the two heat removal route: in the first case the heat removed by the cooling down system is finally transferred to the essential service water (ESW) system, in second case the heat removal through the emergency core cooling systems heat exchangers are also provided by the ESW system. Consequently, the loss of ESW can be interpreted as loss of ultimate heat sink.

In the seismic PSA, long-term loss of ultimate heat sink means that successful interventions aimed at recovering this function are not taken into account.

Damages identified in the seismic PSA assessment that cause the loss of ultimate heat sink are as follows:

- Soil liquefaction that causes island-like settlement of the main building, which causes damages to the systems connected from outside to the main building (such as underground pipelines including essential service water pipeline);
- Concurrent damage of the components characterized by the upper threshold value. These include, among others, the main elements of essential service water system, such as the essential service water pumps themselves;
- Concurrent damage of the electric and instrumentation components characterized by lower threshold value, such as certain circuit breakers and relays required for operation of essential service water system;
- Concurrent damage of the mechanical components and structures characterized by lower threshold value, such as brick walls of the water intake control building, the collapse of which impairs the operation of essential service water system;
- Damage of the building complex (reactor hall, longitudinal electric gallery and turbine hall), which causes damage to the essential service water pipelines;
- Damage of the water intake directly causes loss of essential service water;
- Damage of the water intake control building impairing the operation of essential service water system.

Further damages identified in the seismic PSA assessment that cause loss of heat removal through steam generators are as follows:

- Damage of the compressor building of high pressure instrumentation air system, which leads to loss of high pressure instrumentation air, and thereby to the spurious close of steam generator isolation valves after some time;
- Damage of the demineralised water tanks obviously impairs the temporary realization of open circuit heat removal. Beyond that, on the long term, it also causes the loss of closed circuit heat removal because makeup of normal feedwater would take place from the demineralised water reserves;
- Damage of the transversal electric gallery impairs the operation of normal, emergency and auxiliary emergency feedwater pumps;
- Falling of the damaged service building over the demineralised water tanks causing damages similar to the one described above. At the same time, this damage plays role in the loss of ultimate heat sink concerning Units 3 and 4.

Further damages identified in the seismic PSA assessment that cause loss of heat removal through emergency core cooling system heat exchanger are as follows:

- Damage of the tanks of the intermediate cooling circuit of the emergency core cooling system, which causes total discharge of ECCS intermediate circuit, which terminates cooling of ECCS-pump sealing, which leads to failure of the pumps on the long term;
- Concurrent damage of low and high pressure ECCS tanks leading to insufficient coolant injection into the primary circuit;
- Damage to the transversal electric gallery impairs the operation of high pressure ECCS.

By considering all of the damage combinations leading to the loss of ultimate heat sink and the vulnerability characteristics related to seismic damages the probability of loss of ultimate heat sink, i.e. the resultant vulnerability was determined.

Probability of loss of ultimate heat sink as final state is shown in Figure 2-9 as function of load expressed in terms of ground acceleration related to Pannonian surface. It is observable that in the case of beyond design basis earthquakes the occurrence of the final state is not at all certain. The mean probability of occurrence reaches the value of 0.5 at 0.42 g acceleration, which acceleration is typical for an earthquake of a frequency less than the design basis.

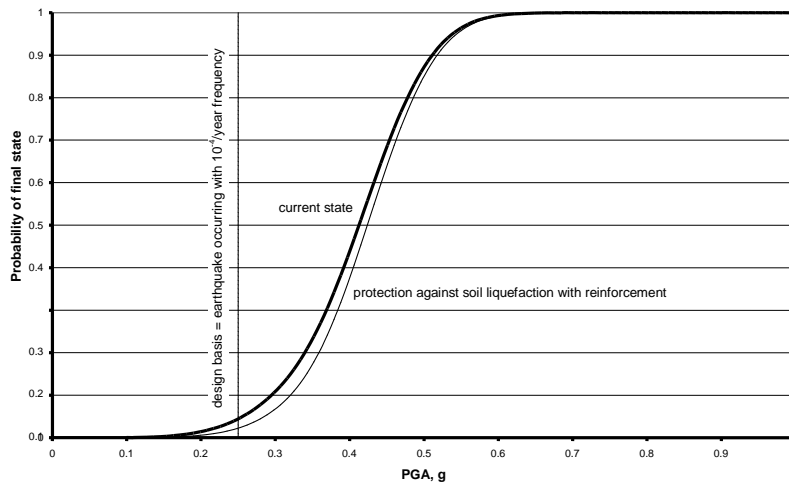

Figure 2-9: Mean probability of loss of ultimate heat sink due to earthquake as function of peak ground acceleration (PGA) related to Pannonian surface

In the lower acceleration ranges the soil liquefaction that causes settlement of the main building plays the dominant role in the occurrence probability of total loss of electric power supply. The reason is that soil liquefaction leads to loss of essential service water system, which alone means the loss of the ultimate heat sink.

If, by reinforcement, it would be successful to improve the characteristics of seismic damage state caused by settlement of the main building due to soil liquefaction to the vulnerability of mechanical components and structures characterized by lower threshold value (0.27 g), then the mean vulnerability curve for the loss of ultimate heat sink would modify as marked with the light line. It is observable that in the case of earthquakes slightly exceeding the design basis earthquake the margins would increase significantly, for example for 0.3 g acceleration the mean probability of occurrence of the final state changes from 0.11 to 0.06.

The described numerical values of the probability of loss of ultimate heat sink or the margins for beyond design basis earthquake are considered to be directly valid for the operation state of the reactor during which the temperature of the primary circuit is above 150 °C. The situation is somewhat more favourable for open reactor operation states. In the remaining operation states, so when the temperature of the primary circuit is under 150 °C but the reactor is not open, the probability of loss of ultimate heat sink is higher than in the described case, so the margin against beyond design basis earthquakes is also lower. Taking into account that these are transient operation states that occur during starting up and shutting down of the reactor, the duration of which is significantly shorter than the other operation states, the lower design margins pertaining to them are not considered as a safety issue.

The probability of loss of ultimate heat sink in the case of the spent fuel pool is low and is not dependant on the operation state of the spent fuel pool.

2.2.2. Range of earthquakes leading to loss of containment integrity

The containment function can be lost due to the following events initiated by the earthquake:

- a) Damage of the containment structure due to earthquake,
- b) Damage of the components performing containment isolation functions,
- c) Inoperability of containment pressure reduction function,
- d) Hydrogen burning, overpressure etc. due to accidents developed from incidents initiated by earthquakes.

The cases according to d) indirectly result in the loss of containment function. Severe accident management is meant to prevent these causes, which is described in Section 6. Consequently, only those cases were taken into account in the analysis during which the effect directly challenges the containment function.

Loss of electric supply or loss of ultimate heat sink can cause the loss of containment function (see point c) above). No other earthquake-induced damage was identified, which would cause the loss of containment pressure reduction function independently of the mentioned ones. Thus no additional investigations were necessary for the containment pressure reduction function.

The containment structure, due to its appropriate robustness and seismic capacity, was enrolled to the group characterized by upper threshold value during the earlier PSA assessments and in the Targeted Safety Re-assessment as well (HCLPF=0.53 g). The reinforced concrete structure, due to its robustness, does not essentially contribute to the vulnerability, and this is not the limiting component from the point of view of beyond design basis margins.

Based on the findings above, the analysis of the earthquake vulnerability of the containment function has been focused on the containment integrity and containment isolation function (hereinafter referred to as containment function).

Damages identified in the seismic PSA assessment that cause the loss of containment function are as follows:

- Concurrent damage of the components characterized by upper threshold value. These include, among others, the elements of containment isolation, such as the isolation valves themselves and the containment building structure;
- Concurrent damage of the electric and instrumentation components characterized by lower threshold value, such as certain circuit breakers and relays required for operation of containment isolation valves and containment venting system;
- Concurrent damage of the mechanical components and structures characterized by lower threshold value, such as brick walls, the collapse of which impairs the operation of most of the isolation valves due to cable damages;
- Damage of the building complex (reactor hall, longitudinal electric gallery and turbine hall), which causes stuck-open of the isolation valves, and damage to the containment suction-compression venting system valves and cables;
- Damage of the transversal electric gallery, which causes damage to ventilators and cables of containment venting system

By considering all of the damage combinations leading to the loss of containment function and the relevant vulnerability, the probability of loss of containment function, i.e. the resultant vulnerability was determined. Probability of loss of containment function as final state is shown in Figure 2-10 as function of load expressed in terms of ground acceleration related to Pannonian surface.

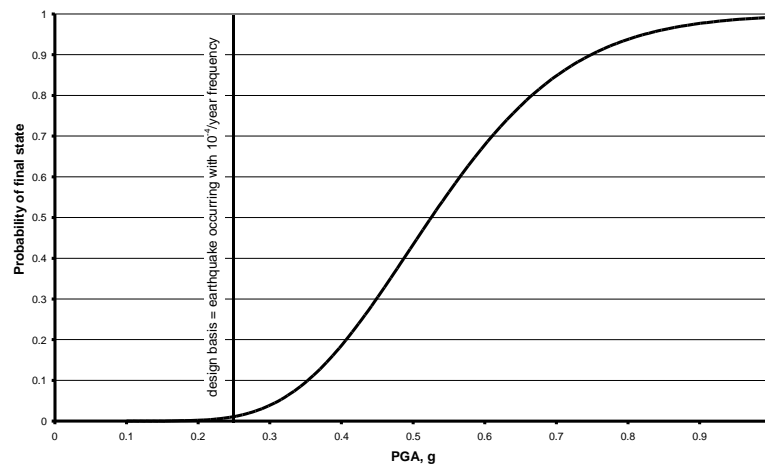

Figure 2-10: Mean probability of loss of containment function due to earthquake as function of peak ground acceleration (PGA) related to Pannonian surface

It can be observed in the figure that the vulnerability of the containment function has significant margins against beyond design basis earthquakes. Mean probability of occurrence reaches the value of 0.5 at 0.53 g ground acceleration, which acceleration is typical for an earthquake of an occurrence frequency of only 10^{-5} /year, which is significantly less than the design basis. On the other hand, the loss of containment function alone does not cause risk to the environment, only if an additional event takes place, which necessitates the availability of the function. Consequently, the containment function should also be assessed in combination with the earlier analyzed events and not considered separately.

Out of the possible ones the combination of loss of electric power supply and loss of containment function and combination of loss of ultimate heat sink and loss of containment function were assessed. These proved to be enough to characterize all possible event combinations. On the basis of the assessment of the first combination it could be determined that the probability of simultaneous occurrence of the events varies only negligibly compared to the probability of loss of containment function, while compared to the probability of loss of electric power supply event alone, the probability of simultaneous occurrence is half in the lower acceleration ranges. In relation to sensitivity to earthquake, the combination of loss of ultimate heat sink and loss of containment function is equivalent with the loss of containment function event.

Containment function is not interpreted for spent fuel pool, since the pool is located outside the containment. Radioactive releases from the spent fuel pool would reach the environment through the reactor hall due to the low retention capability of the reactor hall.

Containment function is not available when the reactor is shutdown and the containment is necessarily opened for refuelling.

2.2.3. Earthquake exceeding the design basis earthquake for the plant and consequent flooding exceeding design basis flood

Flooding hazards of the Paks NPP site is discussed in Section 3 in details. Section 3.1.1 describes the effects of the event when an earthquake causes damage to the Gabčíkovo hydro power plant upstream on the Danube.

2.2.4. Measures which can be envisaged to increase robustness of the plants against earthquakes

It is noted that there are more such items in the list below, which also appears in other sections, since it connects to that topic (e.g. loss of electric power supply, loss of ultimate heat sink or management of severe accidents).

1. In order to increase the plant seismic safety the seismic qualification and, if necessary, further reinforcement of the following reinforced concrete items should be performed. These items had no such qualification before and have no direct safety function.
 - 400 kV and 120 kV substations,
 - barrack of fire brigade,
 - shelters and the non earthquake-proof equipment of the shelters,
 - side walls of the medical building located next to the demineralised water tanks of Installation II.
2. The issue of automatic reactor shutdown shall be reviewed in the frame of reconstruction project of earthquake instrumentation, which is in the phase of preparation.
3. Measures are required to fix the full scope of the tools and equipment used during the maintenance and stored at the units, which may jeopardize the safety related equipment.
4. The measures to prevent the failures due to building settlement caused by earthquake have to be determined. The phenomenon of building settlement and soil liquefaction has to be therefore

further investigated to more precisely determine the available margins. Based on the results of the assessment the underground line structures and connections have to be re-qualified or, if necessary, they have to be modified to make their relative displacement possible.

5. Adequate protection has to be installed to stop the main condenser coolant pumps when the main condenser coolant pipeline damages. It should be ensured that the pipeline trenches are applicable to receive and drain the discharged water. If necessary, the slope has to be elevated or a protective dam has to be constructed to avoid the flooding of the turbine hall or the cable tunnels.
6. The available symptom-based emergency operating procedures have to be reviewed so that they support the optimal recovery after simultaneous occurrence of an earthquake and rupture of the primary coolant circuit.
7. The methods to provide the appropriate conditions for radio transmission has to be reviewed taking into account the occurrence of long term loss of electricity and earthquake and the necessary measures has to be determined.

2.2.4.1. Further improving measures specified by HAEA

8. It has to be analyzed if the lack of seismic qualification of the filter structures (machine racks and travelling water band screens) of the essential service water system may jeopardize the ultimate heat sink function and, if necessary, the adequate measures has to be implemented.
9. The database containing seismic safety classification of the components has to be reviewed to provide that the classification is in agreement with the information given in the licensing documentation of seismic safety improvement modifications.

3. Flooding

This section describes the regulatory requirements for flooding, the method how the design basis shall be determined and the design basis itself. Potential flooding conditions due to special circumstances (damage to upstream structures, ice-packing) are examined separately. Protection of the site against flooding is evaluated based on these considerations.

3.1. Design basis

The plant is installed on the right bank of the Danube. Two reasons might lead to its flooding conditions: natural flow pattern of the Danube and damage to upstream structures (dams). Govt. Decree 89/2005. (V.5.) Korm. that was effective during the development of the plant's report, specified different requirements for considerations of hazard factors of natural and artificial (not deliberate) origin. The content of the new decree that came into force since the completion of the plant's report did not modify the circumstances in this respect. According to these requirements the natural origin flooding conditions, as in the case of every external natural hazard, shall be determined with a recurrence frequency of once in 10,000 years. Concerning hazards due to failure of man-made facilities or man-induced (not deliberate) factors even the cases of 10^7 years recurrence frequency which practically means all physically possible cases, shall be taken into account,

3.1.1. Flooding against which the plant is designed

Evaluation of flooding hazards of natural origin was based on the statistical assessment of the following characteristics collected at the local water-gauges (for the period 1916-1985):

- time series of annual peak water levels,
- time series of annual open river high-water conditions,
- peak flood levels in the section of the site,
- runoff and duration data of water levels.

It was determined by using Gumbel distribution that in the vicinity of the site the level of icy flood of 10^{-4} /year frequency is Bf 96.07 m (water height above the level of Baltic sea), while the level of open river flood is Bf 95.51 m. In the vicinity of the plant site the formation level of the embankment on the opposite, left side of the Danube is Bf 95.80 m, which is lower than the formation level of the right side embankment, which is Bf 96.30 m. The filled up level of the site is Bf 97.15 m, which is higher than both flooding levels, therefore flooding from the Danube need not be taken into account in the design basis of the NPP and its systems (see Figure 3-1). Flooding hazard of natural origin shall not be taken as basis for design of safety systems of the plant.

No.	Name	Level (Bf m)
11	Filled up level of Paks NPP site	97.15
10	Formation level of embankment on right bank	96.30
9	Icy flooding in design basis	96.07
8	Formation level of embankment on left bank	95.80
7	Peak water level at the back of ice pack	95.90
6	Open river flooding in design basis	95.51
5	Typical spring water level	91.00
4	Typical autumn water level	87.00
3	Calculated level in cold water canal during design basis low water flow	84.04
2	Minimum level required for operation of condenser pumps	83.60
1	Minimum level required for operation of essential service water pumps	83.50

(Bf m) – water height above Baltic se level

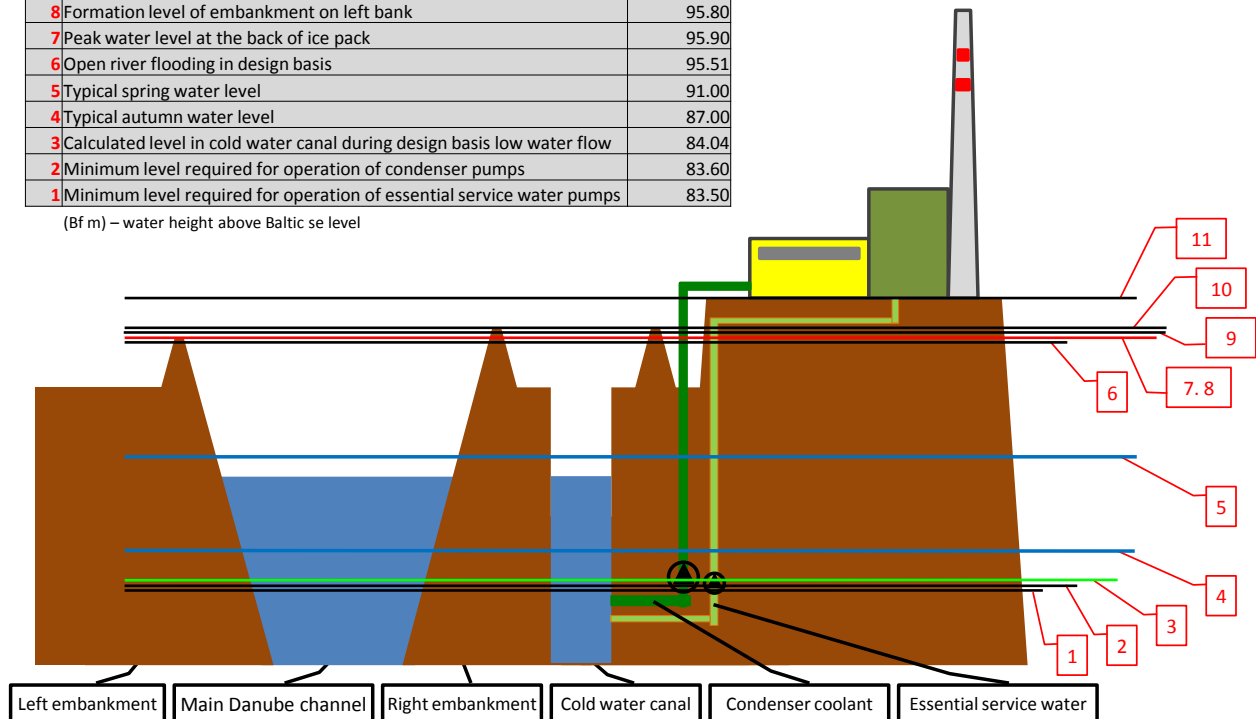

Figure 3-1: Levels at the site of Paks NPP

Important flooding hazard by human activity can only be caused if the dam of the hydro power plant of Gabčíkovo (Bős) breaks. The assessment of the situation also covers the case when the dam breaks due to earthquake. Detailed analysis of the case took place for the purpose of the TSR using one-dimensional hydrodynamic model. The worst situation in the river section of the hydro plant was taken as basis, which was determined from the historically worst lasting high water conditions in 1965 using the time series of the flood-wave of the Bratislava section of the Danube. Since the flood flow experienced remained under the formation level of the local embankments, the flood flow was modified so that the peak flood-wave level reaches the formation level of the embankment. In addition, the worst failure of the reservoir of Gabčíkovo (resulting in additive downstream flood-wave) was assumed. It was taken into account that the reservoir gate is fully open as in the case of high Danube runoff, (if it cannot fully open then the river would flood above the formation level of the upstream embankment, which would decrease the flood-wave level of the downstream sections) and the failure occurs for the effect of a sudden closing during the falling stage of the flood-wave, which generates a new flood-wave. In order to further increase the effect of the worst flood-wave it was assumed that each of the three significant tributaries of Danube (Vág, Garam and Ipoly) feeds the Danube with maximum flood-wave such a way that the runoff flow of the tributaries enters the Danube when the runoff of the Danube also peaks. With such conservative assumptions the highest water level at the section of Paks NPP is Bf 96.14 m, disregarding the fact that the level on the left bank is 34 cm less. Since this water level falls behind by 1 m to the level of the site, flooding hazard needs not be taken into consideration.

The hydrodynamic model was also used to examine the case of ice-pack in the downstream section of the site. According to the results of the analysis the maximum water level developed was Bf 95.90 m, which means a peaking of 10 cm above the formation level of the left bank embankments. Thus a temporary elevation of the left bank embankments would not cause flooding of the NPP site.

In the period of flood-response the opportunity of active intervention in the affected section of the river at the NPP, e.g. elevation of the formation level is limited. The flow pattern of the Danube and the forecasts mean 4-5 days allowance, which limits the length of sections where intervention might be taken and the extent of intervention (the height of an emergency dike that can be constructed during such a time-span is maximum 0.5-0.6 m).

At this stage already level III of flood protection response takes effect and the management and coordination of the response is carried out by the National Technical Management Staff, which shall consider the safety aspects of the NPP.

According to the conditions described above, in the course of passing of the flood wave the highest calculated water level is 96.14 m in the vicinity of Paks NPP. In this case the water level exceeds the formation level of the embankment for 16 days on the left bank around the NPP, while the right embankment is not exceeded. A water level that would exceed the formation level of the embankment on the right bank or the site elevation level, which is situated even higher, is not possible even in the case of extreme high-water loads.

3.1.2. Provisions to protect the plants against the design basis flood

According to Section 3.1.1 it can be concluded that the buildings and equipment important to nuclear safety in or near the main building do not require special measures to protect against flooding. The machine rooms of essential service water pumps in the water intake works are located under the design basis flood level. There are certain wall penetrations in the machine room of the essential service water pumps above the level Bf 95.12 m. The penetrations are not provided with water sealing, so flooding of the machine room may occur if a flood exceeding this level takes place. The water penetration through the walls would accumulate in a sump and a permanently installed sump pump can remove it. Modification of the wall penetrations to a sealed design will increase the availability of the essential service water pumps.

3.1.3. Plant compliance with its current licensing basis

It is unambiguously based on the above considerations that regarding the protection against floods the plant complies with its design basis, which is consistent with the laws.

In practice, the safety systems of the plant are not jeopardized by floods, since probability of flooding of the site is negligible. Consequently, no any special preparedness is necessary for the protection of the plant. On the west side to the plant the public road network providing the access to the plant is located at or above ground level, so the plant can be accessed even in extreme flood situations.

Protection against flooding of machine room of essential service water pumps can be provided by the installed sump pumps alone. If the sump pumps are inoperable the plant has several pumps (e.g. fire pumps) available to be installed to remove the intruding water. Planned sealing of the penetrations, however, will increase the availability.

3.2. Evaluation of safety margins

3.2.1. Estimation of safety margin against flooding

Since the ground level of the site is by 0.85 m higher than the formation level of the embankments around the plant, flooding of the site is not anticipated. According to model calculations performed with conservative assumptions, even the damage to the water reservoir of Gabčíkovo could cause only such a water level elevation which remains 1 m below the ground level. Consequently it was determined that flooding of the Danube cannot result in the loss of basic safety functions of the NPP.

3.2.2. Measures which can be envisaged to increase robustness of the plants against flooding

According to the considerations above flooding of the plant site can be practically excluded, so no measures are identified in that respect. Since the peak level of the Danube taken into account in the review is above the machine room of the essential service water pumps, it is reasonable to increase the availability of the pumps by the modification of the penetrations of the machine room wall to water sealed design.

4. Extreme weather conditions

According to Section 4.117 of Nuclear Safety Code, among extreme weather conditions “large wind blasts, precipitation, accumulated ice and snow barrages, lightning, extreme high and low temperatures and drought” shall be taken into account. Drought, as extreme and lasting condition, affects the plant through the low water-level of the Danube, so this case is discussed here. Since effects of natural origin are assessed the initiating events by natural phenomenon with less than 10^{-4} /year recurrence frequency can be screened out from the scope of postulated initiating events included in the design basis. Nevertheless, safety analysis shall take into account the external events of lower frequencies as well and probabilistic assessment shall be performed down to 10^{-7} /year frequency.

4.1. Design basis

In order to consider the vulnerability of the plant to natural hazards, the first step is to determine the design loads for the given effect and the assigned anticipated frequency.

In the course of determination of the occurrence of extreme weather conditions it is a fundamental problem to estimate the probability of such events which probably cannot actually be observed. The available sample originates from a very limited period of data collection, therefore, the result will contain significant uncertainties.

In relation to extreme weather conditions to be taken into account in the design basis, in line with the international practice, Gumbel approach of the extremities was used since the parameters characterizing the meteorological conditions can usually be described with normal, lognormal, exponential or gamma distribution.

Using such methods the following extreme weather conditions of 10,000 year recurrence were taken into account in the design basis according to the plant’s Final Safety Analysis Report updated in 2009 (based on the data measured locally for the period 1980-2006):

Hazard factor	10,000 year extreme	Measured extreme value	Design value
Wind blast	43.2 m/s	24 m/s	48.8 m/s
Max. daily precipitation	212 mm	130 mm	-
Max. snow thickness	153 cm	53 cm	1.5 kPa snow load
Max. temperature	45.6 °C	37.5 °C	-
Min. temperature	-38.1 °C	-30.3 °C	-

The effect of drought for the NPP means low water-level of the Danube. According to the Hungarian regulations, in relation to fresh water cooling, the availability of cooling water required for nuclear safety shall be evaluated from the aspect of runoff, minimum water level and the duration of such situations. Additionally, those events of natural or human origin shall be determined which might cause long term loss of cooling (blockage or divergence of the river, emptied reservoir etc.). Variation of water-level of the Danube means external hazard, since the loss of essential service water because of lasting low water-level should not be tolerated even in case of shutdown reactors.

Concerning low water-level and low runoff of the Danube statistical methods similar to those used for weather conditions were applied to determine low water-level of 10^{-4} /year frequency (by using approximately 100 years long time series of annual low water-levels and low runoff): Bf 84.65 m. Opposite to that, nearly such a low water-level occurred in the Autumn of 1983 (Bf 84.77 m) that was originally not planned and special solutions had to be applied to provide the operability. As it

was revealed the runoff was consistent with the statistics but artificial modifications of the river bed (sweeping) resulted in a lower than anticipated water-level. Since that time the sweeping of the river bed is duly controlled, the length of the essential service water pumps were extended downwards, their suction elbows were replaced, which solutions provide that the pumps can be started and operated at water levels as low as Bf 83.5 m.

4.1.1. Re-assessment of weather conditions used as design basis

During the TSR a new hazard analysis were prepared on the basis of the latest meteorological data available: observations between 1980 and 2010 by the Paks meteorological station of the Hungarian Meteorological Service were used as input data. 10^7 /year recurrence frequencies with the various confidence levels were determined for each external hazard. It was determined by studying the vulnerability curves that the margins are significant, so it is not assumable for any of the meteorological parameters that a small variation would cause drastic degradation in the load conditions and sudden failure. Possibility of cliff-edge effect is not considered in this respect. The assessment was performed by an expert organization independent of the one that performed the analysis for FSAR (Final Safety Analysis Report). Preliminary results of the assessment are summarized in the table below:

Hazard factor	10,000 year extreme value
Wind blast	41.5 m/sec
Max. daily precipitation	138 mm
Max. snow thickness	107 cm
Max. temperature	46.9 °C
Min. temperature	-47.6 °C

It can be concluded from the table that except for the temperatures, the re-assessment identified lower extreme values compared to the former results. The assessment is not accomplished; its results have not yet been submitted to the authority for approval.

The assessment covered the maximum temperature of the Danube water, but it has no safety importance, since there is 30 °C limit on the discharged coolant temperature in the environmental regulations, so the plant shall be shut down before the temperature of the Danube water would reach the theoretical extreme value. The analysis supports that removal of decay heat would still be possible if the temperature of the Danube would increase even to 40 °C.

Description of lightning needs a methodology different from the evaluation of other meteorological factors, since lightning cannot be characterized by a single parameter. Consequently, the design basis concerning lightning cannot be specified as a single value, but shall be demonstrated how it complies with the standards. Lightning is part of the design basis of safety classified buildings and open air technological equipment of the NPP. Electro-magnetic effects of lightning have to be taken into account in the design basis of safety classified instrumentation and control equipment of the NPP.

A special series of examinations were initiated by the NPP for the purpose of the TSR to re-assess the various hydrological analyses. These assessments have not been completed yet and, therefore, the authority could not afford yet to evaluate it in essence and details. The assessment covers several such potential situations which have not been evaluated beforehand: e.g. abnormal operation of the barrage of Gabčíkovo in extreme low water-level situation (retention of more water than possible per the regulations) or ice-packing in the upstream section in low water-level and low runoff situation or sliding of elevated river bank causing change in river bed etc. The study, also taking into account the climate change tendencies and the factors influencing the water use in the upper sections of the river, determined the minimum runoff assumable at the NPP as 631 m³/s.

With such an extremely low runoff the water-level is not lower than Bf 84.04 m. Essential service water pumps can operate with due margins at this level.

4.2. Evaluation of safety margins

4.2.1. Estimation of safety margin against extreme weather conditions

In the course of the last Periodic Safety Review (2007-2008) it was already determined that in the case of certain meteorological hazards, which are less critical compared to an earthquake, it is not fully and systematically documented if the loads caused by the hazards, which have not been screened out on the basis of their frequency, are appeared for each operating modes in the design basis of certain systems important to safety. The necessary corrective measures were determined and the implementation is in progress.

In the frame of the measures a systems technology evaluation is prepared to determined all those systems and building structures, in the design basis of which the effect of an external hazard should appear. The influence of the given external effect on the safety functions is systematically established for these systems and building structures. Subsequently an item-by-item verification of the documentation is carried out concerning the compliance with the design basis and completeness of documentation. If necessary, the given system of the enveloping building is reinforced. This work is still in progress.

An engineering evaluation has been already completed in relation to the safety electric power supply systems, the preliminary results of which are described below.

4.2.1.1. Extreme wind load

Loss of external electric grid due to the consequence of extreme wind is possible only if all transmission lines leaving the site damage due to the wind blasts. The systems of safety electric power supply, i.e. the emergency diesel generators are installed in adequately protected buildings, therefore, the loss of them need not to be considered for the effect of wind load.

Secondary effects accompanying extreme strong winds (e.g. sand, dust) may also endanger the electric power supply systems. There is no direct sand/dust effect in the closed rooms without glass walls and the venting, air conditioning systems are provided with dust filters. Extreme amount of dust or a dust cloud travelling through possibly damaged glass windows does not endanger the passive components (cables, distributors, batteries), but the dust that might deposit onto the contacts of relays, magnetic switches and circuit breakers, may increase the resistance and might cancel the operation. The dust protection of such devices and safety related cabinets has to be further examined.

Control cabinets of the emergency diesel generators are duly qualified and protected against dust. Dust load may affect the electric cabinets of the machines also only trough damaged windows, but these cabinets are closed. Open air safety sub-distributors of the emergency diesel sub-station are provided with appropriate dust protection.

The system providing the combustion air for the emergency diesel generators sucks air from the internal atmosphere during start-up, then, after taking up the speed, the shutter switches and air is sucked from the external atmosphere through a filter chamber. On the basis of operational experience sand storms have not caused filter choking till now. In lasting operation in very dusty air choking of the filter will certainly occur. The filter cannot be replaced in service. By manual intervention, the shutter can be switched to internal air suction and the long term service of the generator is then ensured.

Switching cabinets of safety electric power supply located in the unit control room are not protected against dust, but such load could not affect them, because they are located far from the windows and the venting system continuously filters the air and also on-scene intervention can avoid the lasting existence of dust.

It can be established that each equipment is protected against extreme sand/dust travelling though damaged glasses or the loss of function caused by lasting dust load can be avoided by venting systems and/or intervention (coverage, venting). Appropriate instructions are in place about the interventions to be implemented in such cases.

4.2.1.2. Extreme high temperature

In-building compartments housing the systems of electric power supply are air-conditioned. If cooling of these compartments is not available an extreme high temperature may develop in the given compartment. The automatism applied in the distributors, control cabinets and most of the relays, small circuit breakers and protections are able to safely fulfil their functions on the long term up to at least +50 °C. For shorter durations (1-2 weeks) significantly higher temperatures are also permissible without impairment of their functions.

Control systems of the emergency diesel generators are guaranteed to operate up to +55 °C, the appropriate service temperature is provided by air-conditioning systems. The circuit breakers, magnetic switches in the open air distributors can safely fulfil their functions up to +60 °C. Higher temperature is not anticipated taking into account the minimum internal heat generation.

The allowed environmental temperature of the electric safety cable compartments is +40 °C. Maximum service temperature of the most commonly used PVC insulation cable is +70 °C.

Air-conditioning and venting system is applied in the battery compartments. Even if the cooling of the compartments would become inoperable and extreme high environmental temperature would occur, no higher than +55 °C allowed for the electrolyte would develop. The higher temperature does not influence the output capacity.

The equipment providing the safe uninterrupted supply can be operated up to +40 °C environmental temperature, lower temperatures are provided by the operating venting systems. If the injection system fails, the equipment may overheat due to intrinsic heat generation. In this case the temperature of the room has to be recovered by venting or installation of mobile air-conditioners, which is ordered for in the manual of the equipment.

Functions of electric safety distributors in other rooms (computer rooms, turbine and reactor hall, unit control room, building of essential service water pumps, auxiliary building) are not endangered by extreme high temperature.

Based on weather forecasts it is possible to prepare for the effects of extreme high temperatures. If electric power is available, the cooling systems are in service and mobile air-conditioners can be deployed. Appropriate operator instructions are in place on the interventions to be implemented in such cases.

4.2.1.3. Extreme low temperature

In-building operator rooms of electric supply system can be heated. Extreme cold temperature does not cause problem in operation concerning the components located in closed compartments without glass walls.

The PVC insulation of the cables can withstand -20 °C, but in the not open air ground tunnels and cable tunnels of the electric galleries no lower temperature, even if extreme cold outside temperature occurs, is expected on the insulation of the cables, which also have intrinsic heating. Certain cables of the emergency diesel generators of unit 1 and 2 might experience extreme cold temperature if the glass window of the building breaks. In such a case, the broken surface has to be promptly covered and temporary heating has to be installed. The personnel inspects the compartments twice in every shift, so a possible window break could be responded to shortly.

Concerning safety of the batteries the lower limit of the electrolyte temperature is 0 °C. Such a temperature may occur only if window break happens. The damaged surface has to be covered promptly and the operation of the heating system has to be verified or temporary heating has to be provided.

Lower service temperature limit of the PLC⁵ and the power supply unit located in the control cabinets of the emergency diesel generators of unit 1 and 2 is 0 °C. The room has heating, so covering of the damaged surface and verification or application of heating has to be provided.

Open air distributors of the emergency diesel generators are equipped with internal cabinet heating.

Based on weather forecasts it is possible to get prepared for the effects of extreme low temperatures. If electric power is available, the heating systems are in service and mobile heating units can be deployed. Appropriate operator instructions are in place on the interventions to be implemented in such cases.

4.2.1.4. Extreme rain, precipitation

Evaluation of the effect of extreme amount of precipitation has not been completed yet. Hydraulic model of the rainpipe network of the NPP has been developed. Critical locations for the various loads will be identified and it will be determined that what equipment important to safety is endangered by a short term flooding at the specific location. Determination of necessary corrective actions is possible thereafter.

Regarding batteries the possible precipitation intrusion cannot cause damage, because the devices are installed on base frames. Open air distributors of the emergency diesel generators are duly protected against precipitation.

Extreme frost deposition and freezing rain jeopardize the transmission lines, this phenomenon has to be considered in the probabilistic analyses as potential opportunity of loss of external grid.

4.2.1.5. Lightning

An external lightning protection system of the plant was designed and constructed according to the respective standards. The lightning protection equipment complies with the 200 kA load both from strength and thermal point of view.

The lightning protection equipment has been re-assessed, improvements were applied in some cases.

At the time of design and construction of the plant the standards and regulations that were effective did not require the construction of overvoltage protection against the electromagnetic impulse of lightning. Regarding the equipment installed during the recent years this protection was provided.

According to the assessments the weather conditions do not jeopardize the connection with the ultimate heat sink, disregarding of the extreme low water-level due to drought. In relation to extreme low water-level of the Danube a new study was prepared, which also covered certain cases of extremely low probability that had not been examined previously. The results showed that the lowest level taken into account in the design basis is not violated even in such cases. Temporary loss of cooling water is theoretically possible for the effect of some secondary events, like the abnormal operation of the Gabčíkovo water reservoir or build-up of ice-pack upstream to the plant. However, forecasts concerning the flow pattern of the Danube provide appropriate time to prepare for such situations. The methodology of preparation is discussed in Section 5.2.2.

Protection of the systems installed in the various technological buildings against external effects is provided by the protective features of buildings themselves and the connected building engineering (venting, air-conditioning, heating) systems. Systems influencing the safety of the NPP are located in the following buildings:

- main service buildings,
- auxiliary buildings,
- water intake works,

⁵ PLC – Programmable Logical Controller

- emergency diesel generator rooms,
- fire water pump houses,
- venting stacks,
- pipe bridges connecting the buildings,
- meteorological tower,
- protected command centre.

Strength and static review calculations were performed recently concerning all these buildings by taking into account the environmental loads according to the design basis. The analyses demonstrated the compliance of the buildings and the protection of the system inside them. In some cases the calculations justified the need of reinforcements, the implementation of which is in progress.

4.2.2. Measures which can be envisaged to increase robustness of the plants against extreme weather conditions

1. Since the flood level taken into account in the design basis exceeds the level of the machine building of essential service water system pump, the modification of the wall penetrations to a sealed design will increase the availability of the essential service water pumps, even if the machine room is equipped with appropriate sump pumps.
2. The review and probabilistic safety assessment decided as the result of the Periodic Safety Review in 2008 for the evaluation of extreme natural effect have to be completed and submitted for authority approval for the designated deadline. Extreme low runoff of the Danube has to be part of the assessment including the re-evaluation of the design basis, if necessary.
3. Building qualifications and, if necessary, reinforcements being in progress to cope with the loads from extreme weather conditions, has to be completed.

A measure considered necessary by the Authority:

4. The list of those system components important to safety which are endangered by electromagnetic effects (including the effects induced by lightning), and thereby needs to be classified, has to be compiled to display whether or not a given component is adequately qualified.

5. Loss of electrical power and loss of ultimate heat sink

A design character of the Paks NPP must be emphasized with regard to these two events, since if one of these events occurred, then it would entail, in a certain extent, the occurrence of the other one; thus these two events are not independent of each other. The electric power supply of safety systems (the operation of the emergency diesel generators) requires essential service water, therefore the supply of this water requires the operation of electrical supplied pumps. Consequently, the assessments made regarding these two events are linked at several points.

The potential causes, the potential modes of prevention and the response to the occurrence of loss of electrical power supply and loss of ultimate heat sink, as well as the potential consequences, and the potential on-site management measures were assessed.

5.1. Loss of electrical power

It should be noted that the systems providing the in-house load electrical power supply of the nuclear power plant are grouped to three categories regarding permissible durations of their loss as defined in the electrical power loss plan (see Section 1.1.2.3).

Category I consumers are safety measurements, automatics, signals and intervening instruments. Their direct electrical power sources are the batteries, whose capacities are sufficient for minimum 3.5 hours even at greatest load.

Category II consumers are active safety components having greater power needs (e.g. pumps). The final electrical power sources of the consumers supplied by Category II electric power are the emergency diesel generators. Category III electric equipment have no safety functions.

5.1.1. Loss of off-site power

5.1.1.1. Island service mode, power supply from the twin unit

The Paks NPP is connected to the national electrical power grid. It can be seen, based on the grid connection system described in Section 1.1.2, that due to the high level of redundancy the total loss of connection would occur only if the national system fully collapses. At the disturbance in or loss of the external electrical power grid the units are automatically separated from the national grid to island service mode and then their power is automatically reduced to in-house load level; thus the units are separated from the national grid, but not stopped (not each one is stopped).

The operation of only one unit on reduced power is capable to supply sufficient electrical power to the in-house load consumers of all four units, as far as the 400 kV substation belonging to the operating unit remains operable. The units being shut down can be supplied either from the 400 kV or the 120 kV substations, if certain parts of them are operable. If a unit is supplied from the 120 kV grid, then at least the operability of the 400/120 kV booster transformer is required. If neither unit is in power mode, nor those parts of the 400 kV and 120 kV substations that belong to the given unit are inoperable, then the unit cannot be supplied externally. Its cooling down requires electrical power supplied by its emergency diesel generators; one of the emergency diesel generators can provide sufficient electrical power.

5.1.1.2. Emergency diesel generators

If electrical power cannot be provided either from external source or from the twin unit, then the automatic start of the emergency diesel generators of the unit will supply the electrical power needed for cooling down. According to the threefold technology redundancy of the safety systems the emergency diesel generators are also composed of three totally independent lines having identical arrangements. The applied threefold redundancy and the independence of the redundant lines guarantee the required highly reliable functioning of the system. The capacity of the emergency diesel generators is sufficient to provide electric supply required by the consumers.

The emergency diesel generators are cooled by the essential service water system; without this system the emergency diesel generators can operate only for a short period of time; in such a case the cooling water is provided by the fire water system (see details in section 5.2). The required measurements and controls are fully redundant and independent. The emergency diesel generator buildings are easily accessible; the required interventions can be performed on the scene. The total loss of all emergency diesel generators is not included in the design basis. Should such event occur, the sufficient long term cooling of the reactor and the spent fuel pool cannot be ensured, only if the external supply would be restored.

In order to guarantee stable operation the Category II consumers are connected to the starting emergency diesel generators through the automatic Sequential Starting Program, according to the power need of the consumers.

Subsequent to the start of their operation, the emergency diesel generators charge the batteries providing electrical power to Category I consumers.

5.1.1.3. Protection against earthquakes and floods

The 400 kV and 120 kV substations are not safety systems; consequently these substations as well as the instruments and elements of the automatics switching to island service mode were not reinforced to withstand a design basis earthquake. The transformers of the substations require active cooling. The measurements and interventions of the substations are supplied from the in-house load rails, or in the case of their loss from their own batteries for the period of 3.5 hours as minimum. Even if the substations do not perform any safety function in case of a design basis earthquake, they can ensure various supply routes if not damaged.

Taking account of floor spectra characterizing their place of installation the safety batteries and emergency diesel generators, as well as the connecting systems and distributors, and the building including the systems of electric power supply are all qualified to a design basis earthquake.

The walls of electronic, instrumentation and control rooms, where the emergency diesel generators, batteries, distributor cabinets, panels and boards are located, as well as the walls meaning potential hazard to these equipment have sufficient resistance or are reinforced to withstand a design basis earthquake. The cable channels and cables of electrical safety systems are equipped with technical solutions limiting their movements under seismic events, or reinforced if needed. The subsequent seismic qualification of cable channels between buildings demonstrated the required robustness. The operability of those equipment being most susceptible to earthquakes that were selected for inspection was verified by vibration tests performed pursuant to the relevant standard. The non-compliant relay types were replaced.

The susceptibility of the electric supply function to a beyond design basis earthquake is evaluated in Section 2.2.1.

With reference to Section 3.1 the design basis of electric supply systems shall not include hazards meant by flooding of the Danube.

In summary it can be stated that Paks NPP is well prepared for the management of the consequences of the externally or internally induced loss of electric power supply; thus the plant is in compliance with the reliability requirements prescribed in the Hungarian Nuclear Safety Code.

The long term operation of the emergency diesel generators is verified by operation tests; they are capable to supply electrical power to core cooling systems. It can be concluded from system reliability analyses that the individual reliability of system components and their architecture guarantees the high level operability of system functions. Each of the 12 emergency diesel generators is equipped with 100 m³ underground fuel tank, in which 70 m³ gasoline, sufficient for 120 hours operation, shall be stored in a way protected against earthquake and flooding. The operation period of the emergency diesel generators without interventions can be extended by almost 30% through the increase of the stored quantity of gasoline.

5.1.2. Loss of off-site power and loss of the ordinary back-up AC power source

5.1.2.1. *Alternative AC power sources on site*

Though the total inoperability of the installed emergency diesel generators is not included in the design basis of the units, several electrical connections exist between the units in addition to the electric power supply system described in Section 5.1.1 regulated by the currently effective operating instructions. These additional electrical connections are also regulated by effective operating instructions.

If the total loss of electrical power does not occur on each unit simultaneously, and the generators operating on in-house load level of certain units or their safety power supply remain operable, then the easiest solution is to provide electrical power through the 400 kV substation, if it is operable.

A solution in principle exists to supply electrical power between the twin units and between the installations, both between normal and reserve 6 kV service systems. The connection between the units from the emergency diesel generators has not yet realized. Since alternative measures play significant role in the prevention of the evolution of severe accident scenarios, therefore the list of corrective measures include the realization of this option and the development of the relating operating instructions. Consequently, the 6 kV safety systems of any unit would be supplied from any operating emergency diesel generator.

The battery supplied, uninterruptible power supply systems are part of the "normal" reserve power supply systems; thus they were described in Section 5.1.1. Alternative battery supplied systems are not available for safety purposes; the installation of such systems does not seem reasonable.

5.1.2.2. *Use of a remote, grid connected gas turbine or other equipment as reserve AC power source*

The remote, grid connected power sources can be used for supplying electrical power to the nuclear power plant, if the relevant power transmission line and switch stations are not damaged or can be restored. The restoration of the external electric power supply has key importance from the aspect of accident prevention measures and long term tasks; the operating instructions of the plant require immediate measures to be performed subsequent to the accident as well as continuous measures for the restoration.

It is reasonable to follow the principles of independence and physical separation even for alternative supply routes, since the natural catastrophes influence certain areas in different way and extent. Currently, the nuclear power plant has two alternative external power routes: one from the "Dunamenti" Gas Turbine Plant located in Százhalombatta and another from the Gas Turbine Plant located in Litér.

External power supply from the Dunamenti Gas Turbine Plant through the 120 kV grid

If the transmission line between Paks NPP and the closest located Dunamenti Gas Turbine Plant is operable, then based on accomplished tests the arrangement of the dedicated supply route and the required switching operations can be performed within one hour both at the system controller and at the plant. Dunamenti Gas Turbine Plant has autonomous power source, which makes possible its start-up without external power supply or the national grid. The realization of the connection diagram described in the relevant operating instruction is exercised by the electrical operators on a specifically developed black-start simulator, while the in-house load electric power supply from external autonomous power source is exercised by the control room operators of the nuclear power plant on the full-scope simulator.

External power supply from the Gas Turbine Plant located in Litér through the 400 kV grid

A power supply route can be realized from the Gas Turbine Plant located in Litér to the 6 kV electric main distributor of the nuclear power plant through the 400 kV transmission line between Paks and Litér. Based on accomplished tests the arrangement of the dedicated supply route and the required switching operations can be performed within one hour both at the system controller and at

the plant. The black-start simulator training of the electric operators includes the realization of the dedicated switching arrangement required by the operating instruction.

Currently, the Gas Turbine Plant in Litér does not have autonomous power source (i.e. own diesel generator); in the frame of this re-assessment the licensee formulated a corrective action in this regard.

Protection against earthquakes and floods

The alternative, external supply routes will not be qualified to earthquakes even after the implementation of corrective measures. Their protection can be evaluated from the aspect that they connect to the site of the nuclear power plant from different areas and directions, and thus a given natural catastrophe would have influenced on both routes simultaneously with very low probability, with the exemption of the substation located on the site. Those on-site elements of the supply routes, which are part of the safety systems are qualified and protected against earthquakes as described in Section 5.1.1.

According to Section 3.1 floods do not mean hazard to systems located on the site of the Paks NPP. Nevertheless, this cannot be stated for the remote, dedicated alternative supply routes, since such an assessment was not performed. It shall be noted that the Litér site is not a flood hazardous area at all, and the potential simultaneous flooding of both alternative supply routes can be excluded.

5.1.3. Loss of off-site power and loss of the ordinary back-up AC power sources, and loss of permanently installed diverse back-up AC power sources

The total and permanent loss of electrical supply, because of its low probability, is not included in the design basis of the plant; however, as a beyond design basis event it was assessed previously and also in the frame of this TSR. The loss of power induces the stop of each AC power consumer; at the same time the chain reaction is stopped by the automatic protection. Without electrical power either the boron concentration of the coolant cannot be increased or the regular cooling down of the unit cannot be performed. Only those battery supplied and compressed air operated systems are available, which provide energy to the measurements and the most important interventions. The secondary circuit pressure can be stabilized and even reduced by the proper application of the emergency operating instruction and opening of the valves reducing the pressure to the atmosphere. The steam relieved in such a way can provide the cooling for a certain period of time. Since the steam leaves the steam generators, but water make-up is not available, the water levels will decrease. Water can be supplied to the steam generators at lower pressure through an alternative supply route.

In the case of accidents occurring during operation at normal power, without electrical power supply and secondary side alternative supply, the steam generators dry-up within four and a half hours after the loss of power, the heat removal gets lost, core damage may occur within about ten hours after the loss of power.

Without electrical power supply the circulation of the cooling water stops in the spent fuel pool. Assuming the most conservative configuration (with the highest residual heat; i.e. all fuel assemblies are in the spent fuel pool after the shut-down of the reactor) and normal water level (that is much lower than the refuelling water level) intensive boiling may start after 4 hours as soonest. Damage to the cladding of the fuel assemblies may commence after about 19 hours (this period might be 25 hours, if the water level is higher).

The electrical power of measurement systems, control circuits, data collectors of safety systems is supplied from DC and AC safety rails that are made uninterruptible by batteries (Category I). It is supplied from that of the three redundant rails, which supplies the concerned technology system as well; thus it can be avoided that the loss of one safety rail may have influence on two redundant equipment. The electrical power of non-technology consumers (emergency lighting, phone, operatory communication network, etc.), according to the importance, is supplied partially from the three redundant Category I uninterruptible power supply routes and partially by the Category I,

uninterruptible, non-safety, non-redundant power routes. Should the normal power supply be lost, the batteries are capable to supply electric power to the measurements and for the necessary interventions at least for 3.5 hours. The emergency diesel generators (or other power sources) starting to operate within this period of time will charge the batteries.

In the case of total station black-out, the prevention of the occurrence of a severe accident scenario is depending on the timely implementation of the appropriate measures. In order to prevent the transient to turn to a severe accident, the personnel must restore the electric power supply or any alternative power supply must be provided within the above defined periods of time.

The emergency operating instruction includes all those measures to manage the condition without electric power supply, which provide delay in the damage to the active core or to the spent fuel pool. Considering that the loss of electric power supply entails the loss of the essential service water system and the spent fuel pool cooling, those measures have to be implemented in addition to the restoration or replacement of the electrical power supply which are required by the alternative cooling or coolant supply options described in Section 5.2.3.

5.1.3.1. Mobile severe accident diesel generators

The severe accident management autonomous energy source mentioned in Section 1.2.2 means a mobile diesel generator that can be connected to a specified contact point on each unit. Their more detailed description can be seen in Section 6.1.2. In the frame of an emergency response exercise the severe accident mobile generators were put into service.

Currently, there are no accessible mobile generators in addition to those severe accident diesel generators existing at the power plant. The fire fighter service of the plant has additional 0.4 kV diesel generators having smaller 5-12 kW capacity, which are only capable to supply power locally.

According to a formerly decided measure, taking account of this targeted safety re-assessment, a concept was developed to install an independent diverse diesel generator per installation or unit. The number and capacity of the diverse diesel generators shall be determined with the consideration of safety principles: they shall have adequate protection against external threats (seismic protection, resistance against natural threats) and their operation shall be fully independent of other systems (e.g. cooling or power supply) of the nuclear power plant.

5.1.3.2. Potential application of off-site mobile equipment

The mobile diesel generators off the site of Paks NPP were accounted with the involvement of the Directorate General of the National Disaster Management Organization and the Hungarian Defence Forces. The availability and the transportation time were also considered. The available mobile diesel generators are applicable to establish local power supply sources and to replace the potentially failed diesel generators. Considering the time constraints needed for their transportation to the site of Paks NPP, these generators can be applied as power sources for the performance of long term tasks after the occurrence of the total black-out; they can support the stable and safe condition of the affected units.

5.1.4. Conclusion on the adequacy of protection against loss of electrical power

The nuclear power plant, with the most comprehensive implementation of the defence in depth principle is prepared for the management of the consequences caused by the internally induced loss of electric power supply, and thus it is in compliance with the requirements of the Nuclear Safety Code.

In the case of disturbance in or loss of the off-site electrical power grid, as the first level of defence in depth the units are automatically separated from the national grid to island service mode and controlled to in-house load level. This reduced power level of only one unit is still sufficient to supply the needed electric power to the in-house consumers of all four units.

The safety is further guaranteed by the establishment of dedicated supply routes from gas turbines of the plants located in Százhalombatta and Litér in order to manage the total black-out at the plant.

If despite the above possibilities electrical power cannot be obtained either from external sources or from other units (for shorter or longer period of time), then the automatic start of the emergency diesel generators of the units is capable to provide the electrical power needed for cooling and for the maintenance of the cold state. The emergency diesel generators compose three totally independent trains having identical construction. The applied three-fold redundancy and the independence of the redundant trains can guarantee together the highly reliable performance of the required system functions and the protection against single failures. The quantity of gasoline stored for the emergency diesel generators provides at least 120 hours operation for each emergency diesel generator.

In the case of the loss of normal power supply, the batteries are capable to supply electrical power to the measurements and for the implementation of the required intervention for 3.5 hours. The emergency diesel generators starting meantime will charge the batteries.

Considering the on-site storage capacity of diesel oil, the quantity of stored diesel oil have to be increased by the modification of the Technical Specifications and the operating instructions in order to enable more than 120 hours service of each emergency diesel generator without supplementation of the gasoline.

The extreme environment effects were not comprehensively taken into account during the design of the nuclear power plant. During the years of operation each affected system was assessed and qualified, and the required seismic reinforcements were accomplished. The technology of cooling and maintenance of the permanent cold condition developed for seismic events can provide the electrical power needed for cooling of the fuel in the reactor pressure vessel and the spent fuel pool and for the performance of other safety functions, thanks to the seismic qualification and reinforcement of the relevant systems. The qualifications and reinforcements were fully completed regarding each system, structure and component needed for the operation of the technology, the confining buildings, support structures, electrical, instrumentation and control systems, as well as regarding the prevention of the interactions causing damages.

The flooding of the Danube, as a source of threat, had not to be included in the design basis of electrical supply systems.

Based on the existing operating instruction, technology information and other operatory experience, all those accident management options were collected and assessed, which can be applied at the Paks NPP in the case of permanent loss of on-site and off-site electric power supply.

In the case of total blackout, the severe accident diesel generators of the units are capable to supply those measuring, controlling and intervention systems that can be used for the implementation of severe accident prevention and consequence mitigation measures. These diesel generators are not capable to supply electrical power to safety supply systems and to the essential service water pumps, therefore in order to manage accident situations the establishment of an additional, diverse diesel generator is decided among the corrective measures. Additional diesel generators having lower capacity are also available on the site, which can be used as local electrical power sources.

The re-assessment identified the possible establishment of such alternative 6 kV energy supply routes through electronic connections between units that were not used so far. Since these connections play significant role in the prevention of the evolution of severe accident scenarios, the licensee's corrective action list includes the development of the necessary modifications and operating instructions.

It can be concluded that alternative and justified off-site electrical power supply routes are available to supply electrical power to the safety consumers of the nuclear power plant, should safety or normal supply is lost on-site. The external power can be supplied from two independent, physical separated sources, through two different routes.

5.1.5. Measures which can be envisaged to increase robustness of the plants in case of loss of electrical power

1. The protection of 400 kV and 120 kV substations and of the automatic switch to island service mode has to be evaluated against earthquakes, and increased if needed according to Paragraph 1 of Section 2.2.4.
2. In addition to the existing severe accident diesel generators supplying electrical power to measurement and control systems described in accident management procedures, it is justified to install a diverse diesel generator, which can supply electrical power to safety consumers having role in severe accident prevention and long term accident management. The capacity of the diverse accident diesel generator has to be determined in such a way that it has to be capable to supply electrical power to the required consumers, pumps and valves. The number and capacity of the diverse accident diesel generators have to be determined with the consideration of the safety principles.
3. With regard to on-site AC power sources, operating instructions have to be developed to manage potential, alternative and not yet used supply routes between the normal reserve and the safety trains of the units as identified during the re-assessment.
4. A feasibility study has to be prepared to improve the potential supply routes between the 6 kV safety systems of the units, in order to find the potential solution ensuring power supply to the 6 kV safety system of each unit from each emergency diesel generator without the use of the external grid. The modifications required by the study have to be realized.
5. The starting ability of the gas turbine located in Litér from an own diesel generator has to be initiated in order to extend the use of this remote gas turbine, which is accessible through the electrical grid.

5.2. Loss of decay heat removal capability/ultimate heat sink

The scope of this re-assessment includes the review and evaluation of the capability of the following systems playing key role in the decay heat removal from the reactor and cooling of the spent fuel pool:

- the essential service water system,
- the demineralised water system,
- the emergency feedwater system,
- the auxiliary emergency feedwater system, and
- the cooling circuit of the spent fuel pool,

as well as of those circumstances which may hinder the removal of the decay heat.

The

- function, operation, capability, and resistance of the engineering barriers as the function of time,
- timeliness and physical limitations of the electric supply, and fuel, coolant and lubricant supply,
- availability and accessibility limits of the associated measurements, intervention tools and intervention locations,
- consequences of permanent loss of the listed systems

were assessed, and the dependency of unit conditions on the operation of other units was reviewed.

Additionally, the re-assessment was aimed to assess and evaluate, based on existing operating instructions, technology information and other operating experience, all those preventive accident

management options, which can be applied primarily to prevent damage to the core and the fuel assemblies stored in the spent fuel pool, to stop the extensive core melting process and to prevent damage to the containment. Accordingly, the following concrete questions regarding the prevention of severe accident processes occurring as a consequence of the loss of the ultimate heat sink are to be studied:

- determination of the period of time available for the implementation of alternative interventions,
- available alternative cooling water sources,
- alternative solutions of accident heat removal, potential supply route of the available water inventory to the volume to be cooled,
- logistical issues required for the realization of alternative cooling options,
- options for the restoration following the loss of the ultimate heat sink.

5.2.1. Design provisions to prevent the loss of the primary ultimate heat sink

The cooling systems, through various routes, remove the residual heat from the reactors and the spent fuel pools, as well as the heat generated in the technology equipment. The heat sink function is realized by the chain of several systems, the ultimate element of which is the Danube. The heat removal from the fuel may be lost, if the connection would lose between the cooling systems of the plant and the Danube. The principal element of this connection is the essential service water system (ESWS) that is installed according to the safety principle of threefold redundancy. Two cooling water pumps in each of the three redundant lines of the ESWS (i.e. altogether 6 pumps/installation) suck the cooling water from the cold water channel through a pre-screening process.

The electrical supply of the ESWS pump is in Category II, works from the essential 6 kV system; thus it can fulfil its function even if the external power supply is lost. The ESW system has no independent fuel supply; the components do not require individual cooling. The components have no oil system, thus they do not need in-service oil change or lubricant supply. Consequently, the operability of the ESW system is not limited by the supply of fuel, coolant or lubricant.

The protection logic controlling the ESWS pumps and valves was installed in a safety instrumentation and control system having threefold redundancy, which is in harmony with the technological redundancy. The relay logic in the switch cabinet guarantees the priority of the protection signals against the operatory instructions. Local operatory interventions are not required by the components of the essential service water system, since the components are remotely controlled. The ESWS can be operated from the unit control room, the reserve control room as well as from the control room of the water intake plant.

From a mechanical engineering point of view, the required independence is provided by the independent lines (screens, pumps, pipelines); the electrical, instrumentation and control supply is provided from independent safety electrical distributors, through independent routes in each system line. From a civil engineering point of view the ESWS pump station is installed in the water intake plant that is common for an installation (i.e. for two twin units); however, the system lines are installed in physically separated and independent rooms. The protection of the ESW system against single failure is primarily guaranteed by the applied threefold redundancy and the independence of the redundant lines.

Safety is improved also by the fact that the operability of certain system components (e.g. pumps) can be restored. The general maintenance practice demonstrated that the pumps of the essential service water system, if failed, could be replaced within 24 hours; both the replacement pump and the entire set of reserve parts are available. The pumps, depending on the water level of the Danube, can be locked and separated; thus their replacement is feasible even if the water level of the Danube is high.

The loss of the electrical power may cause such a problem that the cleaning of the screens (i.e. machine bar screen and band screen) installed in the inlet line of the essential service water pumps

would stop, since they do not have safety electrical supply (a rotating equipment having drum filter cleans further the water, and it has safety electrical supply). Each of the three screen systems requires regular cleaning. According to the operating experience the blockage process is slow; the significantly over-designed screens are capable to provide the essential service water pumps with sufficient quantity of clean water for several days. Nevertheless, it cannot be excluded that if the loss of the electrical power influences all four units, and thus the pre-screener stops, then the drum filters will be blocked after certain period of time, and then the ESWS will be lost.

During the original design process of the systems providing the ultimate heat sink, the external effects were not comprehensively considered in the design basis. Later on each concerned system was reviewed and qualified; the required reinforcements were accomplished, or in the case of a few equipment the reinforcement processes required by certain extreme meteorological effects are still in progress.

Section 3 describes that flooding of the Danube as a hazard had not to be considered in the design basis of the ultimate heat sink systems; thus the seismic resistance of these systems, the low level of cooling water and the protection against extreme meteorological effects have to be evaluated.

In the second phase of cooling subsequent to earthquakes the essential service water system transports the heat from the cooling down system to the ultimate heat sink. Those parts of the cooling systems, which are required for the management of a post-earthquake situation were qualified and reinforced in the frame of the seismic resistance improvement programme. The separation of those parts that are not required by the cooling technology is performed by the installation of isolating valves.

Each building providing room for the above mentioned system was reinforced to withstand the design basis earthquake. The soil liquefaction inducing settlement of buildings might be a significant mode of damaging in the range of acceleration beyond the design basis. The uncertainty of the calculation results regarding the settlement of buildings does not make it possible to exclude that the extent of the earthquake induced soil and building settlement would exceed those values which were used as basis in the frame of the seismic upgrading programme. The connection points of the underground pipelines and cables leading to the main building would be critical with regard to different extent of settlement and relative movements of the buildings and the cables, since the latter ones are placed in unloaded soil (see Section 2).

The low water level of the Danube means a requirement only for the design basis of the essential service water pumps among the ultimate heat sink systems. The drive shafts of the rotating wheels of the essential service water pumps were extended, the suction elbows were replaced earlier; and thus the pumps were moved to a lower level. Accordingly, the pumps can be started and operated without cavitation at Bf 83.50 m water level, as lowest.

It can be determined regarding other extreme environmental effects that:

- The systems of the ultimate heat sink are placed in a building providing sufficient protection against wind load. The systems, structures and components are not susceptible to other wind induced effects (e.g. sand, dust).
- The essential service water system is well protected against extreme external air temperatures, because its components are underground cables or elements placed in closed reinforced concrete shafts. The control room of the water intake plant is equipped with large glass surfaces; in the case of their damage the operatory activity will be more difficult, but not impossible.
- The issue of extreme rains, snowfalls, lightning are discussed in general in Section 4.

Since the blockage of the water intake point and its water-less condition have not to be considered at Paks NPP according to Sections 2, 3 and 4; therefore neither alternative water intake points nor equipment preventing blockage are included in the design of the plant (and its facilities).

5.2.2. Loss of primary ultimate heat sink

The loss of the essential service water system is to be interpreted as the loss of the ultimate heat sink. The effects of external events within the design basis are described in Section 5.2.3.

Section 4 of this report discusses the potential occurrence of low water levels. If the water level of the Danube is extremely low, then the pre-screening parts of the water intake plants are separated from the cold water channel by block-gates. Two block-gates were established for both installations, each of which is equipped with three submersible pumps. Two closable holes having 1 m x 1m cross sections are on the wall of the pre-screening pool, above the gates. According to the action plan for low water level, the gates are taken into the water. In addition to the submersible pumps that provide cooling water through the gates, eight diesel driven feed pumps placed on floating pontoons provide, through the holes, sufficient quantity of cooling water to the pre-screening pool.

The occurrence of low water level is a continuous process in time, thus it can be followed by the operator. According to the documents regulating the operation, the following four-stage actions shall be performed as a function of water level (the water level of Bf 85.00 m means undisturbed operation):

stage	water level (Bf m)
Stage I	85.00-84.50
Stage II	84.50-84.00
Stage III	84.00-83.50
Stage IV	<83.50

After the activation of Stage I the operability of the diesel driven pumps is inspected and their old batteries are replaced with freshly charged ones.

After activation of Stage II the port of the nuclear power plant is prepared for the actions listed under Stages III and IV, the diesel driven pumps are prepared for transport, both lines of the cooling down systems of the units are brought to operable condition. The screen-resistance of the pre-screens of the essential service water system pumps is kept below 0.1 m by increasing the cleaning frequency of the screens.

After activation of Stage III the installation of feeding submersible pumps providing reserve supply to essential service water systems is commenced. Additionally, the installation of the diesel driven feed pumps providing reserve supply to essential service water systems is started. The shutting down and cooling down of the units are started, if the water level is not sufficient for the operation of the normal (non safety) cooling water pumps.

(The actions to be performed if Stage IV is activated are described in Section 5.2.3.) The feasibility of the above actions was tested once, but the re-assessment led to the conclusion that the regular inspection, maintenance and testing of the equipment listed in the action plan are not comprehensive.

The effects of high water levels of the Danube on the essential service water system are discussed in Section 3, while its resistance against earthquakes is discussed in Section 2.

5.2.2.1. Residual heat removal from shutdown reactor

The demineralised water system plays a significant role if the ultimate heat sink is lost, should it occurs due to unmanageable low water level or any other reason. Even if the stop of the demineralised water preparation plant stops the make-up of the system, its water inventory can be used for long-term removal of the residual heat of the core. The demineralised water tanks are reinforced against earthquakes; they are able to withstand the direct loads of a design basis earthquake by the application of additional anchors. As it is described in Section 2.1.2, the three

tanks of Installation II are in direct vicinity of the service building, what may cause problems in case of an earthquake. The relevant statements are revealed in the above referred section.

Three demineralised water tanks having 900 m³ capacities are installed per twin-units, which shall continuously include 500 m³ water inventory as a minimum. The required water quantity was determined from the consequences of the design basis earthquake, based on such assumptions that the normal in-house and grid electrical power supply are lost for 72 hours after the earthquake and that the demineralised water preparation plant does not operate as well. In this case the demineralised water will be, on both units of the installation, the only source of cooling from the secondary circuit.

According to the principles of redundancy and independence, the demineralised water system is protected against single failure; it is able to perform its function if one line is lost. The demineralised water pumps have no individual fuel supply, do not require individual cooling, have no oil system; they do not need oil replacement or lubricant supply. Consequently, the operability of the system is not limited by fuel, coolant or lubricant supply. The demineralised water pumps and the connecting motor operated gate valves have Category II electrical power supply; the electric power is supplied from the safety essential 6 kV system; therefore they perform their function even if the external power supply is lost. The measurements of the system guarantee the control of the service parameters and the limit values required for automatic actuations (based on the control logic). The quantity of water available in the tanks and required for the performance of the safety function can be controlled both on local level gauges and through measurements from the common service control room.

During the accidents of the unit, as planned, the emergency water to the secondary circuit can be supplied by the demineralised water system, through seismic reinforced system components, in two ways as follows (see Figure 1-7):

- if the emergency feedwater pumps of the emergency feedwater system work, then the unit is cooled by water supplied from the feedwater tanks to the secondary side of the steam generators; the water from the feedwater tanks is continuously made up by the demineralised water pumps with 65 t/h capacity;
- if the emergency feedwater pumps are not able to stabilize the water level of the steam generators, the auxiliary emergency feedwater pumps supply water directly from the main pipeline of the demineralised water tanks to the steam generators.

In an accident situation the demineralised water system is made up from the make-up water preparation plant, thus the demineralised water inventory of the tanks might be considered. Taking account of the normal state, since the cooling down system cannot be operated without the essential service water system, the inventory of the tanks is sufficient for cooling for more than two days. (If the cooling down system can be put into service, then due to the more effective water use the water inventory might be sufficient for three days.) This period of time is available for the restoration of the essential service water system or for the realization of other preventive measures. It is obvious that increasing the water inventory stored in the demineralised water tanks will increase the above interval. Additionally, the demineralised water systems of the two installations can be connected to each other, what can further improve the safe water supply.

If a unit of the Paks NPP shuts down under accident conditions (e.g. due to the loss of the essential service water system), then the above mentioned emergency feedwater system is needed for the removal of the residual heat, which system supplies feedwater from two feedwater tanks to the steam generators by two pumps having 65 m³/h capacity. (The service of the system requires demineralised water for supplying water as closing water to the gasket box and as cooling water to the bearing.) As it was discussed above the demineralised water make-up stops in many various scenario (e.g. due to the loss of electric power supply), but sufficient quantity of water is available in the demineralised water tanks both to cool the pumps and make-up the secondary side. This water quantity is sufficient to complete the normal cooling down process.

The electrical power to the emergency feedwater system is supplied by the Category II safety system, thus it re-starts after the loss of electrical power as the demineralised water pumps do. The emergency feedwater system is earthquake resistant. Lubricant supply is not required by the pumps being in service.

Taking account of the results of formerly made system reliability analyses it can be stated that the individual reliability of the components composing the system, their redundant and diverse arrangement in the required extent, and the construction of the support systems, electrical, instrumentation and control systems together guarantee the availability of the system functions even if the assumed failures will occur. The protection of the feedwater supply function against single failure is assured also by the availability of the auxiliary emergency feedwater system described below, which can supply coolant to the secondary side of the steam generator in an alternative way.

The function of the auxiliary emergency feedwater system is to supply water directly from the demineralised water tanks to make-up the steam generators to remove the residual heat of the reactor, should the normal feedwater and emergency feedwater systems fail. The delivery capacity of the pumps (two pumps per unit) is identical with the emergency feedwater pumps. The emergency feedwater system is totally independent of the auxiliary emergency feedwater system. If one of the systems fails, then the other will perform the safety function.

The supply route of the auxiliary emergency feedwater system is independent of the normal service feedwater system. The water supplied by the system comes from the demineralised water tanks; this water is used as cooling water for the bearings. The system, the demineralised water tanks and the connecting demineralised water pipelines are all earthquake resistant. As a result of a formerly implemented safety improvement measure the pumps and control valves of the system were moved from the turbine hall to the reactor building, where they are well protected from external effects. The system was then re-designed in compliance with the single failure criterion.

The electrical power to the auxiliary emergency feedwater system is supplied from the Category II safety system, thus it starts automatically as supplied by the emergency diesel generators in the case of loss of the electrical power. The auxiliary emergency feedwater system is earthquake resistant. Lubricant has not to be supplied to the pumps when in service.

With the consideration of the formerly made system reliability analyses it can be concluded that the redundancy of the auxiliary emergency feedwater system and the independence of the redundant lines are sufficient to guarantee that single failure will not cause the loss of the feedwater function in the case of design basis accidents.

5.2.2.2. *Residual heat removal from the spent fuel pool*

In order to improve the safety of cooling and the availability of the cooling system, the cooling of the spent fuel pool is performed by two independent redundant cooling circuits (each capable to individually perform the function in full extent); each contains a heat exchanger and a pump. The cooling circuit leads the water of the pool to the heat exchangers, the secondary side of which is supplied by the essential service water system. Accordingly, the spent fuel pool is ultimately cooled by the essential service water system.

The cooling circuit of the spent fuel pool is qualified and reinforced to design basis earthquake. Analyses demonstrated that the reinforced concrete block of the reinforced reactor building maintains its structural integrity under loads induced by the design basis earthquake; thus reinforcement was not required during the execution of the seismic improvement programme. The details of the seismic safety of the spent fuel pool are discussed in Section 2.1.2.

As a consequence of the loss of cooling in the spent fuel pool, the water of the pool warms up, and then boils. Based on conservative assumptions the boiling process commences after about four hours, the damage to the cladding will commence after about 19 hours. Accordingly, in the case of loss of spent fuel pool cooling as a design basis accident, sufficient time is available for the personnel to implement the procedures established in the emergency operating procedures. In line

with these procedures, the periodic use of the coolant stored in the tanks of the emergency core cooling system can delay the warm up process until the personnel can restore the cooling of the essential service water system. The spent fuel pool cannot be cooled, if the essential service water system is totally lost, because coolant cannot be supplied to the heat exchangers of the normal cooling system and the cooling water and the closing water of the gaskets of pumps to be used for periodic water replacement in accident situation are also supplied by the essential service water system.

Only in shutdown state, when the refuelling pool is filled up, can the cooling of the spent fuel pool be performed through connection of the primary circuit and the spent fuel pool, through the primary or the secondary circuit, even if the essential service water system (the ultimate heat sink) is lost. It can be concluded that the loss of the ultimate heat sink is independent of the service state of the spent fuel pool.

Finally, it should be noted that the effects of earthquakes beyond the design basis regarding the heat removal are discussed in Section 2.2.1. The quantitative vulnerability values of buildings, commodity groups, systems, components determinant to the loss of the heat removal can be found there, together with the assessment on how the risk induced by earthquakes beyond the design basis depends on the service states of the nuclear power plant units at the moment when the accident occurs.

5.2.3. Loss of primary ultimate heat sink and alternative heat sink

5.2.3.1. Permanent loss of the ultimate heat sink when the external electric power supply is available

The re-assessment was made with the assumption that the site cannot be accessed by heavy vehicles within the first 72 hours after the initiating event, and even the light, portable equipment cannot be brought to the plant and put into operation in the plant within 24 hours.

The loss of essential service water supply cannot occur as single event due to the loss of the ultimate heat sink (e.g. due to unsuccessful implementation of the response plan), the loss of water supply of the main condenser cooling water and technology cooling water have to be assumed as well, since their water source is identical, namely the cold water channel that connects to the Danube. If such an event occurs, the units will shut down, the primary circuit pumps will stop, and thus the primary circuit will be cooled in natural circulation service mode. The loss of the cooling water means also that the steam generated in the steam generator can be removed to the atmosphere only, and thus the water inventory will run out soon. The emergency feedwater pumps supply the steam generators from the feedwater tanks, which are supplied from the demineralised water tanks. If the emergency feedwater pumps are not capable to stabilize the water level in the steam generators or the water runs out from the feedwater tanks, then this function has to be performed by the auxiliary emergency feedwater pumps that suck directly from the main pipeline of the demineralised water tanks.

Considering that the total shutdown of the water intake plant has to be assumed in this case, and thus the make-up of the demineralised water will be lost, and only the demineralised water inventory stored in the tanks can be used. With reference to their normal condition, the inventories are as follows:

- 2x120 m³ water in the feedwater tanks per unit,
- 6x70 m³ water in the steam generators per unit,
- minimum 3x500 m³ water in the demineralised water tanks per twin-units.

The need for demineralised water is dependent on whether the units are to be cooled down or kept in hot reserve. In the latter case the need for water is smaller, but it is obvious that if the ultimate heat sink is lost permanently, then it is reasonable to bring the units to cold down state. According to the analyses, the water inventories are sufficient for three days to cool the units.

After the feedwater tanks and the demineralised water tanks become empty, the personnel continue to execute the existing emergency operating procedures; their activity is aimed to provide continuous water supply to the steam generators. In order to postpone this event, the quantity of stored demineralised water has to be maximized by the modification of the Technical Specifications and the operating instructions, considering that the total utilization of the storage capacity of demineralised water tanks was not a requirement so far.

When the demineralised water inventories run out, the only chance to supply water to the auxiliary emergency feedwater systems (that are independent for the units of the installation) is through an independent external connection from another source. The mentioned connection to the outlet collectors of the auxiliary emergency feedwater systems of the twin units (that can be joined together) has been already installed.

The fire water system can be primarily considered as a water source. The primary water source of the fire water system is the bank filtered well plant, which is capable to provide 810 m³/h water flow rate at a pressure of 8 bars. Additionally, the fire water pump station of the plant having 4000 m³ water inventory is available, which is supplied from the discharge water canal of Installation I. The pumps of this station start automatically, should the need for fire water exceed the flow rate provided by the wells. If the pressure of the fire water system decreases below the lower service value, then the earthquake resistant diesel fire water pumps that suck from the outlet line of the essential service water system of Installation II start automatically.

It can be seen that the fire water system is able to cool the steam generators on low pressure for an unlimited period of time, should the electrical power supply being available. The demineralised water inventory available in the tanks is sufficient to maintain the cooling of the units for the time interval that is needed by the operators to implement the measures necessary for the arrangement of water supply from the fire water system.

If at the moment of the loss of the ultimate heat sink a unit is in shutdown state, then the situation is more advantageous than that described above, since the need for demineralised water is less, because that unit is in cold condition.

The spent fuel pool is cooled by the essential service water system. If it is lost, then no other designed cooling system exists currently. The potential actions in the case of loss of the spent fuel pool cooling are given in Section 5.2.2.

5.2.3.2. *Potential alternative cooling water sources*

One option is the application of the fire water systems of the plant. The essential service water system can be supplied from these sources, but currently they are capable to solve the alternative cooling water supply only in a limited extent. The fire water pump stations can be operated only if the normal electrical power supply is available; they have 2x2000 m³ water inventory reserved in the discharge water canal; their permanent service can be guaranteed only if the cooling water systems are in operation.

The fire water pump station operating with diesel pumps having fuel reserve that is sufficient for about eight hours of operation is also available. Nevertheless, the current arrangement makes possible to provide 100 m³ cooling water without the operation of the essential service water system of Installation II. In the case of total station black-out, the diesel pump station (that is independent of the electrical power supply grid) can be a valuable alternative source of cooling water; therefore the operator decided to introduce a corrective action in this regard in order to extend the water inventory to be used in the case of an accident.

The nuclear power plant has 9 wells each having a large diameter and a depth of 30 m that are bored in the pebble bed of the Danube (this is the so called bank filtered well plant that was mentioned in the previous section); these wells are permanent water sources providing unlimited quantity of water independently of the water level of the Danube. A connection system is installed from the well plant to the essential service water system. Unfortunately, these bank filtered well plant is not

applicable currently to permanently avoid the loss of the final heat sink if the external electric power supply is lost, because it is operated by 15 submersible pumps having 385 kW nominal capacity which are supplied from the normal electrical grid. Nevertheless, the water base and the already installed connection possibility make it valuable as an available alternative source of cooling water; therefore the operating organization developed a corrective action with regard to the realization of an electrical power source independent of the external electrical power supply.

An alternate water supply is meant by the possibility to supply the technology cooling water systems in both Installation I and II from the fire water system. This is important because the consumers of the essential service water system (used for cooling of the emergency diesel generators, cooling systems of emergency pumps and heat exchangers, etc.) can be supplied through the technology cooling water system. The connection already exists on Installation I, only the isolation valves have to be opened; the realization of the connection on Installation II requires a further modification, which was identified as a corrective action.

Currently, the cooling water of the emergency diesel generators can be supplied from the fire water systems. The operation of the emergency diesel generators with cooling system supplied from the fire water systems is an accepted and well tested practice during the maintenance of the units. It is obvious that the emergency diesel generators can be started accordingly even in accident conditions, and they can be kept in service until the restoration of the essential service water system. So far the fire water system was connected by disassembly of the essential service water system of the emergency diesel generators and assembly of a connection element, and only one assembly set is available per installation. The cooling of at least one emergency diesel generator on each unit from the fire water system will be implemented as a safety improvement measure.

In addition to all those solutions mentioned above, the cooling water can be supplied by mobile water intake directly from the Danube, the cold water channel of the Danube, or from the fishing lakes located at the border of the site. Those lakes contain about one million cubic meters of water. The mobile water intake can be performed by the plant fire fighters with the available equipment; sufficient quantity of water at adequate pressure can be supplied to the connection of the auxiliary emergency feedwater system. The water quantity required in the case of simultaneous occurrence of accident on each unit was determined by analysis; it was justified that this type of external water supply is sufficient to avoid overheating of the reactors. The installation of the pipelines system needed for the mobile water supply was exercised by the fire fighters as described in Section 6; a photo taken during the exercise can be seen in Figure 5-1.



Figure 5-1: Installation of the mobile water supply system

An assessment was made, with the involvement of the Directorate General for National Disaster Management and the Hungarian Defence Forces, on the mobile diesel driven pumps available off the site. The results of the assessment are shown in Section 6. During the assessment, similar to the assessment on the mobile diesel generators, the availability and transport time limitations were also considered. Taking account of the above described time requirements for the transportation to the plant site, these diesel pumps are only applicable to support the installed mobile cooling water supply, which is required for the performance of long term tasks; they may facilitate the stable safe condition of the affected units for a longer period of time. The equipment available on site have to be primarily applied to avoid damage to the core, to stop the extensive core melting process, and to avoid damage to the containment; therefore the equipment transported from off the site are not considered during the assessment of preventive measures in the frame of this re-assessment.

5.2.3.3. *Alternative heat removal options through the steam generators*

In those severe accident situations, when the auxiliary emergency feedwater system cannot be used for filling the steam generators, and according to the effective emergency operating procedures steps shall be taken to prepare low pressure feedwater sources for the steam generators and to reduce the pressure of the steam generators. Should the auxiliary emergency feedwater system be out of service, the low pressure cooling water can be supplied to the steam generators from the yard connection of the auxiliary emergency feedwater system from the demineralised water tanks through alternative routes, and from alternative water sources by a well tested mobile water supply mode as mentioned above.

It should be mentioned that the auxiliary emergency feedwater pumps, the twin-unit connection possibility and the manual valves of the water supply from the yard are all installed in a single room. The pumps belonging to different units are physically separated in the common room by fire resistant walls. The safety implications of the installation in a common room, with its advantages and disadvantages, was previously evaluated in the probabilistic safety analysis of the nuclear power plant.

It has to be considered that in the case of loss of the ultimate heat sink (or total loss of electrical power supply) the realization of external electrical power supply is a measure serving for the

prevention of the occurrence of the severe accident; thus it has to be implemented before the core damage. Since in such cases the loss of the auxiliary emergency feedwater system is caused not by the installation in a common room; therefore the arrangement of pipeline connections needed for water supply can be performed by the operator personnel on the scene. In this phase of the accident the dose conditions are not severe; therefore the access to the equipment is not limited. An advantage of the common room is that it is enough to activate the mobile water supply at one point for both units of an installation.

Water supply opportunities are available in addition to those listed above from the feedwater tanks through the existing filling pipelines of the high pressure preheaters; however, these sources are difficult to be supplied in the case of a severe accident.

By the use of those options described above the mobile water supply is currently solved. In order to facilitate the practical application during accidents, as an additional corrective measure, the installation of points at the demineralized water tanks where mobile connections are possible were envisaged.

5.2.3.4. *Alternative options for water supply to the containment*

After the loss of the ultimate heat sink, an external water source may be necessary if the water inventory available in the containment is used up and run out. (E.g. the significant water inventory stored in the localization tower within the containment is used to prevent damage to the reactor pressure vessel, to flood the reactor cavity, to limit the containment pressure on longer term; thus such use of water, namely the long term management of severe accident scenarios will require alternative water sources.) The potential solutions are summarized below.

The modification including the installation of the feedwater side relief valves was finished on each unit to manage primary to secondary leakages. These relief valves, if needed, can let the water to the floor of the hermetic compartments from the secondary side of the steam generators. The above discussed external (low pressure) feedwater, supplied from an alternative source, can be transported to the containment through these relief valves. Electrical power for the relief valves can be supplied from the existing severe accident diesel generators (that are described in Sections 5.1.3 and 6.1.2), and can be remotely opened. The water can be supplied from the yard to the steam generators only if the personnel arrange the pipeline schedule in the auxiliary emergency feedwater system. In a severe accident situation, when water has to be made up to the containment for the long term management of the situation, the establishment of the connections are influenced by the radiological conditions in the room. The access to the external connection point under accident conditions has to be evaluated, and if required has to be modified; this is planned to be implemented, as a corrective measure, by the operator.

The water supplied to the containment as described above can be used for the external cooling of the reactor cavity without any limitation, even if it dilutes the boron acid concentration of the fluid within the containment. If the external electrical power supply is successfully restored, then the emergency core cooling systems supplying water to the reactor pressure vessel will be restarted, and they circulate the water available in the containment, if their tanks become empty. On the other hand it is not permitted to supply water having lower boron acid concentration than that of leaking from the primary circuit and the regular cooling systems to the reactor in such a case when the condition of the reactor core is unknown after the accident, since it may bring the core to a critical state again. Therefore, the boron concentration of the water supplied to the containment has to be set; the boron concentration shall be at a level that can guarantee the required concentration in the tanks of the emergency core cooling system. A corrective measure was identified by the operator to solve the safe application of the alternative water supply to the containment.

5.2.3.5. *Alternative cooling of the spent fuel pool*

In the case of available electrical power, the cyclic use of the water stored in the tanks of the emergency core cooling and other cooling systems (use and re-filling) can solve the cooling of the

fuel assemblies until the cooling of the spent fuel pools will be restored. Nevertheless, the spent fuel pools have no existing dedicated, external, independent water supply opportunities.

According to the effective emergency operating instruction, the water make-up (without energy source) can be provided by the gravity forced discharge of water to the spent fuel pool from the upper trays of the localization tower. It should be considered during the evaluation of this solution that the water inventory stored on the trays of the localization tower might be required for other purpose if a simultaneous accident occurs in the reactor, and that the manual operability of the valves on the discharge route depends on the local radiological conditions. In order to improve safety, in the case of permanent loss of the ultimate heat sink, the licensee plans to implement a corrective measure assuring the long term cooling of the spent fuel pools by the establishment of a new, independent and protected supply route. (The water can be reasonably supplied by the use of mobile equipment, similar to the alternative supply to the containment, even from identical water sources.) Since the issue of criticality may appear depending on the safety of the fuel stored in the spent fuel pool, thus the boron concentration of the water shall be set as of that supplied to the containment.

5.2.3.6. Summary of alternative cooling routes

According to the previous sections both the closed and the open circuit heat removal processes require water supply. The feasible alternative cooling routes are summarized in Table 5-1 with the indication of the logistic conditions for the realization.

Those rooms and building parts were identified during the re-assessment, where safety improvement connections have to be installed between the fire water systems and the technology cooling water systems and between the technology cooling water systems and the essential service water system. The results showed the locations needed improvements as follows:

- at level -4 of the turbine engine hall,
- in the room of the auxiliary emergency feedwater pumps,
- in the technology pump machine houses.

The above mentioned system connections, after their realization, will provide great freedom from the aspect of water supply.

Those external areas of the plant were also assessed, which require the presence of personnel to perform the connections to be applied in the frame of the above mentioned alternative cooling methods. The results show required presence of personnel at the locations listed below:

- water intake plant,
- environment of the discharge water canals, together with the water level maintaining structure,
- environment of the bank filtered wells,
- environment of the diesel driven fire water pumps,
- building and environment of the water softener.

Table 5-1: Summary of alternate cooling routes with the indication of certain logistic conditions

Alternate cooling options	Fluid, available quantity	Capacity	Required personnel	Equipment	Power source
Bank filtered wells – technology cooling water system – essential service water system	Filtered stratum water, practically unlimited	810 m ³ /h	Opening of connections, normal service personnel	-	Electric energy
Plant fire water pump station – technology cooling water system – essential service water system	Danube water from the discharge water canal of Units 1&2 2x2000 m ³ *	2x120 m ³ /h + 3x288 m ³ /h	Normal service personnel + water authority personnel		Electric energy, emergency diesel generator, diesel oil
Diesel fire water pumps – technology cooling water system – essential service water system	Danube water from the discharge water canal of Unit 4 2000 m ³ *	2x330 m ³ /h	Normal service personnel + water authority personnel		Diesel generator, Diesel oil
Fire fighter vehicles, Diesel pumps in cascade	Danube water, practically unlimited source	120 m ³ /h	Plant facility fire fighters personnel + own personnel	Fire fighter vehicle, Diesel pump, hoses	Diesel generator, Diesel oil
Demineralised water tank park	6*800 = 4800 m ³	8*65 m ³ /h	Normal service personnel	-	Electric energy
Essential service water system /fire water system - technology cooling water system – make-up water softener – demineralised water tank park	Practically unlimited source	8*65 m ³ /h	Normal service personnel	-	Electric energy

* The available water quantity can be increase with the application of diesel feed pumps installed on the pontoons.

5.2.4. Conclusions on the adequacy of the protection against the loss of the ultimate heat sink

In the frame of the re-assessment, with regard to systems performing the function of the ultimate heat sink, the compliance with the internationally accepted criteria for nuclear power plant design and with the criteria defined in the currently effective Hungarian Nuclear Safety Code was evaluated. Especially, the regulations of Volume 3 of the NSC (Design of nuclear power plants) shall be complied with. The scope of the re-assessment covers the evaluation of the compliance

with the safety philosophy, performance of safety functions, reliability requirements as well as with the fundamental design requirements.

The regulations of the NSC require to analyse the total loss of the ultimate heat sink among the beyond design basis events in order to identify those event sequences, during which reasonable preventive and mitigation measures can be determined and applied. In these cases, the margins existing based on the construction of the nuclear power plant unit have to be analysed, including the operation of certain systems and components under circumstances differing from the original design state and function, as well as the application of provisional systems and components to restore the nuclear power plant unit to a controlled state and to mitigate the consequences of the accident.

Those nearby, remote, mobile or different purpose cooling water supply opportunities, routes and mitigation options have to be taken into account in the frame of the review, which are capable to fully or partially restore the cooling water supply to those systems performing safety functions, which play essential role in the prevention of the degradation of the severe accident or its consequences.

The flooding of the Danube as a source of hazard was excluded from the design basis of the ultimate heat sink systems. The former modification of the essential service water pumps enables to start the pumps and operate them in cavitation-free condition in case of water levels below the water level defined in the design basis. In the frame of the last periodic safety review the operator has already identified the corrective measures on the systematic assessment of loads induced by certain hazards having meteorological origin; the implementation of these measures is still in progress (see Section 4.2.1). Regarding the ultimate heat sink systems, the system engineering inspections made so far have not revealed any such problem that may refer to significant hazard.

Consequently, the total loss of the ultimate heat sink will not occur as a consequence of events belonging to the design basis of the nuclear power plant. (The design of nuclear power plants guarantees in general, and specifically the design of the Paks NPP guarantees that the total loss of the ultimate heat sink is very improbable; it may occur only as a consequence of events or combination of events beyond the design basis.) Nevertheless, the scope of the re-assessment has to cover the loss of the ultimate heat sink as a consequence of such beyond design basis events that can be assumed rationally.

It can be stated based on the results of the re-assessment that the fundamental principle of the safety philosophy (namely the defence in depth concept) was properly applied to the construction of the safety systems playing a relevant role in the prevention of the loss of the ultimate heat sink:

- One pump of the two belonging to a subsystem of the threefold essential service water system is capable to assure normal operation; if it is lost then the second, reserve pump starts automatically. One line of the demineralised water system, with its three pumps, can alternately satisfy the needs of the normal operation.
- The design basis of the systems guarantees adequate response to the design basis accidents entailing the most adverse consequences.
- Operating institution and action plans are available for the management of accidents beyond the design basis.

The systems are in compliance with the reliability requirements of the Nuclear Safety Code, since they were constructed with adequate level of redundancy, their subsystems are independent of each other; they are adequately protected against both single and common mode failures.

In the analyses of events belonging to the design basis, in harmony with the international practice, the operatory failures were taken into account among the single failures. The plant management continuously strives for the reduction of failures induced by human errors.

The various levels of beyond design basis earthquakes and the associated risk of the permanent loss of the ultimate heat sink were analysed during the re-assessment; thus the margins of the ultimate heat sink function with regard to beyond design basis earthquakes were identified. It can be

concluded based on the results that the systems of the ultimate heat sink will not be necessarily damaged in the case of the occurrence of a beyond design basis earthquake; however the probability of their damage increases with the strength of the earthquake. The failure mode determinant in smaller acceleration ranges was identified; it is the soil liquefaction inducing the settlement of the main building. It was evaluated how the establishment/reinforcement of the protection against such soil liquefaction can increase the margins. It was revealed that the margins are significantly greater in the case of earthquakes that are not much stronger than the design basis earthquake. Consequently, a safety enhancing corrective measure was identified in this regard (see Section 2).

The probability of the loss of the ultimate heat sink and the quantitative values of the margin regarding beyond design basis earthquakes are directly valid for the service states when the temperature of the primary coolant is above 150°C in the service state of the reactor. The situation is a bit more advantageous in service states when the reactor is open. In other service states, when the temperature of the primary coolant is below 150°C, but the reactor is not open, the probability of loss of the ultimate heat sink function is greater than the given value, thus the margin regarding beyond design basis earthquakes is smaller. Considering that these are transient service states during the shutting down and starting up of the reactor (few hours in a year), the smaller design safety margin does not mean any safety risk.

Since time limitation does not exist regarding the duration of the service state of the closed reactor when the temperature of the primary coolant is below 150°C, a probabilistic safety analysis has to be performed to assess whether a time limit considering the balanced distribution of risk is reasonable to be established and introduced.

The probability to lose the ultimate heat sink of the spent fuel pool is small and independent of the service state of the spent fuel pool. In the case of the spent fuel pool, the success of preventive interventions aiming to avoid severe fuel damage requires their timely implementation. It can be concluded that the fuel damage will commence after 10 hours (as a minimum, depending on the situation) following an accident occurring during power operation; the fuel damage starts after 19 hours (as minimum) in the spent fuel pool. The interventions implemented within the time interval available before the fuel damage starts may prevent severe damage to the fuel and its melting. (The real melting of the fuel, if the preventive interventions are not implemented, will start a few hours later than mentioned above.)

The available cooling water sources were identified in the frame of the re-assessment, their applicability as coolant was assessed. The alternative options for heat removal from the steam generators were assessed and the logistic conditions needed for the realization of the alternative cooling possibilities and their availabilities were identified. The conclusion can be drawn that several independent alternative cooling water sources are available, and that the personnel and equipment resources will be adequate after the execution of the identified corrective measures. The possible cooling solutions of the fuel stored in the reactor and the spent fuel pool were reviewed; the restoration possibilities of the ultimate heat sink function were analysed. The review identified that the ultimate heat sink can be restored in several ways; solutions can guarantee the cooling of the core and the spent fuel pool in diverse modes.

5.2.5. Measures which can be envisaged to increase robustness of the plants in case of loss of ultimate heat sink

Those corrective measures are listed below, the implementation of which can improve the resistance of the Paks NPP against the loss of the ultimate heat sink in a way that they prevent or mitigate certain deficiencies beyond the design basis as described in Sections 5.2.1-5.2.4.

6. The safety electrical power supply of band screens have to be solved in order to prevent the blockage of the screens of the essential service water system.
7. Comprehensive inspection, maintenance and operational testing shall be introduced regarding those equipment that are to be applied in the frame of actions planned to be implemented in case

of low water level. The still missing inspection, testing and maintenance procedures have to be prepared.

8. The covering panels of the service building have to be qualified to the design basis earthquake in order to guarantee the availability of the potentially jeopardised three demineralised water tanks of Installation II (see Section 2).
9. The operator has to maximize the continuously available inventory of the stored demineralised water by the modification of the Technical Specifications and the operating instructions, with the consideration of the free storage volume of the demineralised water tanks.
10. The water base of the earthquake resistant fire water pump station of Installation II that is equipped with individual diesel power supply and capable to operate for eight hours can be utilized only if the cooling water systems are operating. The accessibility of the 2x2000 m³ water reserve available in the closed segment of the discharge water canal has to be solved by implementation of necessary modifications for such cases when the supply from the essential service water system is lost.
11. The electrical power supply of the submersible pumps of the bank filtered well plant has to be established by a well protected fix or mobile diesel generator in order to guarantee their applicability in severe accident situations.
12. Similar to the connection existing on Installation I, the water supply has to be solved from the fire water system to the essential service water system through the technology cooling water system.
13. The equipment necessary for the cooling water supply to at least one emergency diesel generator of each unit from the fire water system have to be available; so as the emergency diesel generator can be started and operated in case of loss of the essential service water. Operating instruction has to be completed with the measures to be implemented for the application of this alternative cooling.
14. Connection points have to be established on the demineralised water tanks to allow the water supply, through the auxiliary emergency feedwater system, by mobile equipment.
15. Based on the existing potential direct cooling water supply to the containment, the use of water containing sufficient boron acid has to be solved with the use of the existing tanks. The potential setting of the boron concentration of water inventories from external sources has to be solved. The supply mode from external source to the containment has to be regulated in an operating instruction.
16. The water make-up to the spent fuel pool from an external source has to be made possible by the construction of a supply pipeline having adequate design against external hazards, with potential connection from the yard. Water inventory with adequate boron concentration (see above) has to be supplied through this line to the spent fuel pool. The operating instructions on the practical application have to be developed.
17. The access to the connection point of the auxiliary emergency feedwater system established for external water supply and to the valves required for its operation under accident conditions has to be reviewed, and modified if needed.

An additional measure judged as necessary by the authority:

18. A probabilistic safety analysis has to be performed to assess whether a time limit considering the balanced distribution of risk is reasonable to be established and introduced.

5.3. Loss of the primary ultimate heat sink, combined with station blackout

Several questions of the specific design characteristics of the Paks NPP were discussed in Sections 5.1 and 5.2 regarding that the safety systems performing cooling are dependent on the availability of the electrical power supply (including the safety electrical power supply), and that the service of the emergency diesel generators providing safety electrical power supply requires the operation of the essential service water system (see e.g. first paragraph of Section 5).

5.3.1. Time of autonomy of the site before loss of normal cooling condition of the reactor core and spent fuel pool

As far as the event is within the design basis and thus the essential service water system remains operable (the ultimate heat sink, namely the water intake from the Danube is available) and the emergency diesel generators are operable, then the time of autonomous operation is limited by the diesel gasoline inventory available on the site, which is sufficient for at least 120 hours service of each emergency diesel generator of each unit (see Section 5.1.1). The service of one emergency diesel generator per unit is sufficient for cooling down; the regrouping of fuel inventories between emergency diesel generators was not considered in the frame of this re-assessment.

If the essential service water system is totally out of service, but the cooling of the emergency diesel generators is successfully solved (e.g. from the fire water system), then the reactors can be cooled for more than two days by the use of the demineralised water inventories (see Section 5.2.2.1).

In case of total loss of cooling, the boiling starts after four hours in the spent fuel pool, according to the most conservative case. Fuel damage starts 19 hours after the occurrence of the accident (see Section 5.2.2.2).

These time intervals can be significantly extended (even now) by the use of alternative water sources (see Sections 5.2.3.2-5.2.3.6). (Alternative electrical power sources are not available currently on the site of the nuclear power plant, but corrective measures are planned to be executed in this regard.)

5.3.2. External actions foreseen to prevent fuel degradation

Among the external interventions on cooling water supply, only those cases have to be mentioned, which require the separation of the pre-screening pool of the water intake plant from the cold water channel by block gates and the application of the feeding pumps. Such cases require contribution from the workers of the state water authorities, as well as the transport of the feeding pumps from an external site. It has to be considered here that the evolution of an extremely low water level in the Danube is not an immediate process; time is available to get prepared, and the occurrence of such simultaneous events hindering access to the site is practically negligible (see details in the introductory part of Section 5.2.2).

In certain situations beyond the design basis, the external interventions play significant role in the restoration of the on-site electrical power supply. Accordingly, electrical supply routes were established and tested from the Dunamenti thermal power plant through the 120 kV transmission line and from the gas turbine located in Litér through the 400 kV transmission line, including black start after the total loss of electric power supply.

5.3.3. Measures, which can be envisaged to increase robustness of the plant in case of loss of primary ultimate heat sink, combined with station blackout

Each of the five corrective measures envisaged in Section 5.1.5 and of the other 13 envisaged in Section 5.2.5 plays role in the improvement of the robustness of the plant even in the case of loss of primary ultimate heat sink combined with station blackout. Among them only the last one of those in Section 5.1.5 is an external intervention: "The starting ability of the gas turbine located in Litér from an own diesel generator has to be initiated in order to extend the use of this remote gas turbine, which is accessible through the electric grid."

6. Severe accident management

6.1. Organization and arrangements of the licensee to manage accidents

6.1.1. Organization of the licensee to manage the accident

Though the severe accident management and the on site emergency preparedness actions (on-site and off-site) are quite different activities, their are interrelated in a complex manner. Therefore the Paks NPP Ltd organized the severe accident management activities in such a way that the interventions on the unit being under severe accident situation is controlled by the Technical Support Centre (TSC) working in the frame of the Emergency Response Organization being responsible for both on-site response actions and communication with off-site response organizations. Obvious advantages of this solution are the easy communication between the ERO and the TSC as well as that response to multi-unit events can be easier organized.

6.1.1.1. Staffing and shift management in normal operation

The safe operation of the plant, in compliance with the effective operating limits, is the task of the operative personnel. The operative personnel performs the continuous service of the nuclear power plant units in the structure defined in the so called Operative Scheme, through functions fulfilled by job positions indicated in the hierarchy associated to the structure. The operative personnel work in 3x8 hours shifts; they are organized in 6 shifts.

The number of the personnel required for the performance of the tasks of the operative personnel (including the personnel of the unit control room), and the composition of the personnel being in duty at a given time are specified based on the service requirements of the potential operating states of the unit. The operative control and executive conditions required for the continuous service of the units are specified for the various design operating states of the nuclear power plant.

The operative leader of the shift personnel of all four units is the plant shift supervisor, who is the ultimate decision maker on essential safety issues and questions not regulated by instructions. The positions directly subordinated to the plant shift supervisor are: the unit shift supervisors, the leaders of primary circuit, secondary circuit, electrical, instrumentation and control, external technology, chemistry and dosimetry services, the foreman of electrical external plants, the shift leader of refuelling machine operators, the computer specialist on duty, the engineer leading the base, the shift leader of the radioactive waste management service, the shift supervisor of the Plant Control Centre, the shift commander the commander of the fire fighters, phone centre manager, the dress room supervisor and the manager of the special buffet. The control room is permanently staffed by the unit shift supervisor, the reactor operator, the secondary circuit operator and the electrical operator.

6.1.1.2. Measures taken to enable optimum intervention by personnel

The operating staff performs its activity according to operating instructions. In the case of a severe accident, subsequent to the activation of the Emergency Response Organization (ERO), the structure of operative control remains unchanged until the Severe Accident Management Guidelines (SAMGs) have to be applied. During the implementation of SAMGs the operative control over the personnel of the affected unit is taken by the ERO Technical Support Centre (TSC) from the plant shift supervisor, who remains the leader of the operative staff. In such a situation the personnel of the damaged unit perform the activity based on purpose oriented instructions, which are directly announced to the control room by the TSC working in the Protected Command Centre (PCC).

In light of the design data the evaluation and control facilities (control rooms, PCC) intended for severe accident management (SAM) are well prepared for the special conditions. If the control room cannot be habited, then the reserve control room is at the disposal of the staff, where the actions required for shutting down and cooling down the unit, as well as those required for the maintenance of the cold state can be executed. If none of the control rooms can be habited, then the

control room personnel keep contact with the TSC from another proper location. In the case of severe degradation in the working conditions the ERO makes decision on the evacuation from the service posts and on the identification of the place applicable for long-term stay (e.g. evacuation to the emergency shelter), or on the permanent leave of the operative area or other areas.

6.1.1.3. Use of off-site technical support for accident management

According to the design aspects considered during the construction, the staff of the TSC is able to manage the severe accident of one unit in full extent. The technical arrangement of the TSC makes possible to manage the severe accidents of two units, however the number of the personnel has to be increased in this case. Currently, if all the experts of the TSC have to be involved, additional shifts cannot be composed. In case of a multi-unit accident, external resources seem necessary to be involved in the performance of fire fighting, technical rescue, medical and law enforcement tasks, since such an extended event cannot be managed by the resources available on site.

6.1.1.4. Dependence on the functions of other reactors on the same site

The Severe Accident Management Guidelines and the tools to be applied to manage such situations are designed (similar to the management of situations within the design basis) in such a way that the resources of each unit are sufficient to manage the situations individually as planned. Accordingly, design dependence on functions and resources of other units does not exist in this regard.

6.1.1.5. Procedures, training and exercises

The tasks of the ERO are regulated by executive instructions, the General Emergency Response Plan and the procedures of the concerned professional areas (i.e. operation, maintenance, radiation protection, etc), which documents are prepared in the hierarchical quality management system of Paks NPP Ltd. The executive instructions regulate the task to be performed in details; these documents include the preparatory and inspections tasks, as well as the practical actions in connection with the elimination of the concrete emergency.

It was concluded from the re-assessment that the above referred documents are entirely available; the only exemption is the documentation supporting the severe accident management activities. The severe accident management documentation was completed by the end of 2011 in the frame of the SAM project; the actions are completed on Unit 1; the first trainings on the use of SAM guidelines was conducted in 2011.

6.1.1.6. Plans for strengthening the site organisation for accident management

The most important measures planned to be implemented for strengthening the site organization for accident management are as follows:

- The methods to guarantee the conditions for radio communication have to be assessed in the case of permanent loss of electric power and earthquakes. Informatics mirror storage computers have to be installed both at the PCC and the Backup Command Centre (BCC) containing the necessary scope of data (i.e. documentation, personal data, etc).
- The procedures for gathering the ERO personnel and for their transportation to the site have to be developed; the required equipment has to be identified and their provisions have to be established. A transportation vehicle providing adequate radiation protection under severe radiation conditions has to be purchased.
- A software based severe accident simulator has to be established.
- The physical arrangement and instrumentation of the Technical Support Centre established at the Protected Command Centre have to be extended to provide sufficient resources for simultaneous management of severe accidents occurring on more than one (even all) units.
- The structure of the organization responding to accidents affecting multiply units and the number of staff have to be determined; procedures have to be developed for personnel and equipment provisions, as well as for shift changes.

6.1.2. Possibility to use existing equipment

6.1.2.1. Provisions to use mobile devices

Independently of the safety electrical power supply system, one severe accident diesel generator is available on each unit; each has 100 kW capacity and provides electrical power on 0.4 kV. These generators are installed on platform trailers and can be hauled; when not in use they are stored in an earthquake protected building on the site of the nuclear power plant. The severe accident diesel generators, according to their design basis, are capable to supply electrical power in the case of station blackout to those measurement, monitoring and intervention systems which are needed for the execution of preventive actions mitigating the consequences of the severe accident (e.g. pressure reduction of the primary circuit, flooding of the reactor cavity, steam generator relief within the hermetic compartments).

Alternative cooling water source can be established by mobile water intake directly from the Danube, from the cold channel of the Danube or from the fishing lakes containing about one million cubic meters of water. The fire fighters are able to perform the mobile water intake and to supply water to the connection of the auxiliary emergency feedwater system in sufficient quantity and on adequate pressure by the tools at their disposal. The water quantity needed by the simultaneous accidents of all four units was specified; it was justified that the heat-up of the reactor can be avoided by external water supply.

An assessment was made, with the involvement of the Directorate General for National Disaster Management and the Hungarian Defence Forces, on the mobile diesel generators and diesel driven pumps available off the site. Taking account of the time requirements for the transportation to the plant site, these diesel pumps are only applicable to support the installed mobile cooling water supply, which is required for the performance of long term tasks; they may facilitate the stable safe condition of the affected units for a longer period of time. The equipment available on site have to be primarily applied to avoid damage to the core, to stop the extensive core melting process, and to avoid damage to the containment; therefore the equipment transported from off the site are not considered during the assessment of preventive measures in the frame of this re-assessment.

6.1.2.2. Provisions for and management of supplies

The underground gasoline tanks and the quantity of stored gasoline are described in Section 5.1.1. It should be mentioned here that taking account of the unused capacity of the tanks, with the modification of the Technical Specification, the service time can be significantly extended.

The essential service water system can be supplied from the fire water systems of the plant; further alternative water source is the earthquake resistant fire water diesel pump station having sufficient diesel oil reserve for eight hours of service, as well as the nine wells having large diameters and depths of 30 m bored into the pebble bed of the Danube. These are described in details in Section 5.2.3.

The supplementation of materials and make-up of stocks may be needed in the case of long-lasting response. Since the stocks were specified based on the 24/72 rule, the transport routes required for supplementation of materials can be considered as available. Tanker vehicles, haulable trailers and small tanks are available for the provision of fuel. The tanks can be used for the transportation of petrol and diesel oil as well. The water and food supply and the make-up of stocks can be provided, from the areas not affected by the accident, by the disaster management organizations having national competence according to the needs identified by the ERO. The vehicles needed for accessing the site are provided by the disaster management organizations having national competence.

6.1.2.3. Management of radioactive releases, provisions to limit them

At Paks NPP, the strategy of severe accident management was determined on the basis of Level 2 PSA results. It is aimed to prevent the occurrence of post severe accident processes that significantly increase the extent of radioactive release and/or to mitigate their consequences.

The steam induced by the external cooling of the reactor pressure vessel may cause slow over-pressurization of the containment. In order to avoid this phenomenon the relevant accident management guideline requires the reduction of the containment pressure according to the "Pressure reduction in the hermetic compartments" instruction. Additional details can be found in Sections 6.2.2 and 6.3.3.

6.1.2.4. Communication and information systems

The following alternative options are available for the communication in the case of an accident.

The phone sub-boards providing the basis for the external and internal wire communication links are located in physically well separated buildings; one sub-board is installed at the Protected Command Centre. The base of internal communication is the Digital Dispatcher Centre installed at the control nodal points, which are connected with loudspeaker lines, phone board extensions and direct lines. A direct communication line to the external cooperating organizations is also at the disposal of the ERO. These provisions guarantee the possibility of immediate communication in the case of an emergency.

Wireless systems can be used for the direction of the on-site emergency response, and for communication with the authorities and external organizations. The following wireless communication systems operate on the site of the nuclear power plant:

- UHF radio system,
- Unified Digital Radio System,
- mobile phones.

In accident situations within the design basis, the UHF radio system is the primary communication tool within 30 km vicinity of the nuclear power plant. Its use, subsequent to the loss of the electrical power supply, due to the loss of amplifiers, is very limited inside buildings. Portable radio sets are provided to the management staff of the plant, the fire fighter service of the plant, the security service, the operating and maintenance organizations, the ERO, as well as other authorized external cooperating organizations. The Unified Digital Radio System is aimed to use for communication with governmental organizations (i.e. disaster management organizations, law enforcement organizations, defence management organizations, defence forces, fire fighters and the national ambulance service). The personnel of the ERO, including the positions of section commanders are equipped with mobile phones.

The following alarm and information systems are available at Paks NPP:

- Acoustic Alarm and Information System,
- Public Information and Alarm System,
- Pannon Messenger System,
- Automatic Calling and Fax-transmission system,
- MARATHON Terra Mailing System,
- Governmental Communication and IT System.

The Acoustic Alarm and Information System operates on wire network; its operability is dependent on the intactness of the network. The system is basically aimed to alarm, first of all in the first phase of an accident.

The Public Information and Alarm System is an alarm and communication system installed within 30 km vicinity of the nuclear power plant. The control centres of the system are installed at the Protected Command Centre, Plant Control Centre and at the Tolna County Disaster Management

Directorate; additionally, a mobile control unit is available. The system consists of 227 sirens, which are capable to communicate alarm signals, as well as recorded or live speeches. The Pannon Messenger system is able to alert those persons, whose names and phone numbers are stored in the system.

The Automatic Calling and Fax-transmission System, through ISDN lines, is applicable to provide groups and individuals with alert messages, as well as to send faxes. The system consists of alerting terminals at the Protected Command Centre and the Plant Control Centre.

The primary tool of information transmission of written documents in the frame of the National Nuclear Emergency Response System is the MARATHON system. This mailing system is applicable to send electronic mails and data to external organizations having proper licenses. The terminals of the plant dedicated for communication are at the Plant Control Centre, Protected Command Centre and at the Backup Command Centre.

The Governmental Communication and Information System is a closed governmental electronic mailing system for the transmission of electronic messages and data to external organizations. The terminal of the plant dedicated for communication is installed at the Protected Command Centre.

The above listed communication systems are susceptible to earthquakes and long-lasting power losses. Corrective measures are identified to handle these issued. The ultimate tool of continuous communication is through personal messengers.

The IT instruments required by the emergency response, which transmit process data of the nuclear power plant units and the radiological situation, also satisfy general purposes, like internal IT information, management of documents, etc.

The IT equipment and the office IT network is connected to the Protected Command Centre through optical cables. The above networks are totally independent; they use individual cables. The network cable schedules of the accident measurement system are earthquake resistant. As a reserve route for the technology IT network an earthquake resistant microware connection having twofold redundancy is available between the Protected Command Centre and Installations I and II; this route is switched off in normal case.

The elements of the office IT network are not equipped by an uninterruptible electrical power supply, thus this network cannot be used in case of loss of electric power.

Access to the technology IT network from the Backup Command Centre is only possible through a web-based interface, but this is adequate to substantiate the emergency response measures.

A mirror storage computer has to be installed for the case if the optical network is damaged. Accordingly, the access to the last mirrored state of documents and personnel data can be ensured for the Emergency Response Organization.

6.1.3. Evaluation of factors that may impede accident management and respective contingencies

6.1.3.1. Extensive destruction of infrastructure or flooding around the installation that hinders access to the site

Taking into account the design data, the area selected for the evaluators and controllers of Severe Accident Management (control rooms and the Protected Command Centre) are prepared to withstand the special conditions. The access routes to those rooms, where personal intervention is needed, are determined by the ERO on the basis of the existing conditions; this information is provided to the personnel through the available communication channels.

Effects of earthquakes

The units can resist those earthquakes without significant radioactive release that do not exceed the level of the design basis earthquake. At the same time significant damages, fires, etc. may occur on

the site as consequences of the earthquake; additionally, the conventional part of the units that are not reinforced to earthquake may be damaged.

Damage to non earthquake resistant buildings may occur on the site; however such buildings are usually far from the main building. In the case of an earthquake goes off during office hours may cause large number of casualties in the office building and other workplaces. The realization of the priority life saving and the searching for casualties may last for several days. The specially prepared volunteer rescue organizations have to be involved to the response activity. Decision on the involvement of these special rescue services has to be made by the organizations having national competence.

In the case of an extremely strong earthquake, the arrival of the rescue forces and the extent of such forces may be limited, since significant damages may occur in the environment of the plant, which also require actions from the external response forces. Involvement of forces from distant, unaffected areas of the country cannot be expected within 12 hours. It is assumed that in the early phase the site can be accessed only by heavy vehicles (i.e. caterpillar type vehicles, heavy off-road vehicles). The use of normal vehicles will be possible only after the heavy vehicles open the way to the plant. Such heavy vehicles are available at the Hungarian Defence Forces and at companies making ground-works. Based on the lessons learned from the "red-sludge catastrophe" (occurred in October, 2010, in Ajka, Hungary) it can be estimated that such heavy vehicles would start their actions on the affected area after about 24 hours.

Effects of extreme weather conditions

An extraordinary blast of wind can entail broken window glasses, obstruction on traffic routes and collapse of higher buildings.

The potential flooding of the site by precipitation affects the health protection facilities in addition to the technology buildings. The points critical to flooding of these facilities are the fork lifter downways; they would be flooded, if the sewage water pumps fail.

If large amount of snow falls or it remains on the roads for a longer period of time (for several days), then disturbances may occur in the traffic on the site, what may delay the activation of the ERO and shift changes of operating personnel, but may not hinder the operation of the ERO.

High air temperature may hinder the emergency management, may cause disturbances in the operation of the ERO; low temperature may cause disturbances in traffic.

6.1.3.2. Loss of communication systems

The cable schedules of wire communication are not qualified to earthquakes. The wire communication systems are equipped with uninterruptible electric power supplies having at least 4 hours capacity. In case of permanent loss of electrical power supply, the wire communication can be maintained through intact cables, after transportation of mobile diesel generators to the scene and their connection to the centres. The availability of outgoing communication can be limited by damages to the national wire network or to external centres.

The re-assessment concluded that the uninterruptible power supply of the base station of the wireless communication radio system makes at least 4 hours operation possible; if needed it can be supplied from a mobile generator, as well. The antenna tower of the radio system is not qualified to earthquakes; if it is damaged as a consequence of an earthquake, then the radio sets may communicate in limited range only (maximum 1-3 km depending on the surface and building conditions). Consequently, the methods how the radio communication can be provided in the case of long-lasting electric power loss and earthquakes have to be identified.

The operability of the Unified Digital Radio System has to be guaranteed by the state.

The applicability of GSM mobile phones provided to the staff of the ERO can be limited in a severe accident situation or after an earthquake, but it is expected that the alerting process can be

completed subsequent to the occurrence of the event. Their permanent use is not considered during accidents.

The Acoustic Alarm and Information System is equipped with uninterruptible power supply which guarantees minimum 4 hours operation.

The remotely controlled Public Information and Alarm System operates until the radio system is in operation. The siren terminals are network-independent, they can operate in local mode; thus the public can be alerted and informed in the case of a severe accident inducing the loss of the electrical power supply and of the electrical power network.

The Pannon Messenger System works on GSM network, its operability can be expected at least in the early phase of an accident for the execution of the first alerts.

The same applies to the operability of the Automatic Calling and Fax-sending, the MARATHON System and the Government Communication and Information System as that was concluded regarding the wire systems.

The above communication systems are susceptible to earthquakes and long-lasting loss of electric power supply. Corrective measures were identified to handle these issues.

6.1.3.3. Impairment of work performance due to high local dose rates

Personal and collective protecting tools are at the disposal of the responders for work performance under adverse radiation protection conditions and in oxygen-less environment. The necessary replacements can be supplied from the stored stocks. The local response activity can be performed under harsh conditions in certain cases; thus the primary objective is to minimize the adverse health effects.

In order to reduce the radiation exposure to the personnel, the access to response points inside contaminated areas or areas showing high dose rate has to be solved by vehicles having adequate shielding factor.

Significant amount of radioactive waste may be generated in the plant during severe accidents. The re-assessment draw the conclusion that the plant is not fully prepared to manage liquid radioactive wastes generated in large quantity during a severe accident.

6.1.3.4. Impact on the accessibility and habitability of the main and secondary control rooms, measures to be taken to avoid or manage this situation

Taking account of the design data, the selected evaluators and controllers of Severe Accident Management (control rooms and the Protected Command Centre) are prepared to tolerate the special conditions. The access routes to those rooms, where personal intervention is needed, are determined by the ERO on the basis of the existing conditions; this information is provided to the personnel through the available communication channels.

If the control room cannot be habited, then the reserve control room is at the disposal of the personnel, where the intervention opportunities make possible to perform actions required for shutting down and cooling of the unit. If none of the control rooms can be habited, then the control room personnel move to a place from where they can communicate with both the Technical Support Centre and the local staff. Only limited interventions can be performed in this case, which can be realized on the scene. The accident has to be managed by the Technical Support Centre and the ERO accordingly.

The operative personnel remain on their workplaces during the management of a severe accident until those places can be kept safe. The ERO makes the decision on the evacuation of the workplaces, operative areas and other areas, if the work conditions severely degrade, and decide on the dedication of places applicable for long-term stay (e.g. moving to a protecting shelter). Later on, the closed areas can/must be accessed only to execute the necessary interventions for the time needed for the execution.

6.1.3.5. *Impact on the different premises used by the crisis teams or for which access would be necessary for management of the accident*

Access to places required for response actions may be hindered by the consequences of external natural effects (flooding, storm, and earthquake induced collapses of buildings) or by the accident scenario induced radiation conditions. It can be concluded based on Sections 2-4 of this report that the probability of the occurrence of those circumstances is very low; being prepared for them is not reasonable. Nevertheless, a corrective measure was identified to solve the access problems caused by radiation conditions by the purchase of an adequately shielded transport vehicle.

The access routes to those rooms, where work performance is required are identified by the ERO based on the existing conditions, and then the personnel is informed through the available communication channels.

6.1.3.6. *Feasibility and effectiveness of accident management measures under the conditions of external hazards*

Effects of earthquakes

A strong earthquake can significantly influence those circumstances and conditions, under which the emergency management system has to work. The personnel and material losses on the site may influence the ERO staff, tools and the applicability of tools (primarily the transport). The extreme environmental effects do not only physically limit the operability of the ERO, but influence the ability of the ERO staff because of psychological effects and worry about relatives.

The earthquake induced loss of the service building may become a problem that cannot be totally excluded. The personal dosimeters may be lost, the change of clothes to protecting clothes will be more complicated. The debris falling from the non earthquake resistant, seriously damaged buildings or their collapsed residues can block the traffic routes and thus hinder the rescue operation.

However, thanks to seismic reinforcements, the units can tolerate the design basis earthquake without significant release of radioactive materials; the ERO continuously monitors the radiation conditions. The radiation conditions have to be taken into account during the sequential execution of the involvement of tool sand forces, as well as during the planning of rescue actions.

The staff number of operating personnel was specified to make execution of the interventions required after the occurrence of an earthquake (four-unit design basis accident) possible. The sufficient number of operating personnel is available on-site in any moment to manage a multiunit accident.

6.1.3.7. *Unavailability of power supply*

The loss of the electrical power supply highly reduces the communication opportunities. The local lighting is guaranteed only until the batteries run down (about 4 hours). If the restoration of the electrical power supply is not successful in the meantime, then the lighting will be lost in the rooms.

In the case of loss of the electrical power supply, the electrical power needed for the operation of the valves required for the flooding of the reactor cavity is supplied by the severe accident diesel generators. The ERO has to get connected to the diesel generator of the affected unit.

6.1.3.8. *Potential failure of instrumentation*

Only limited information (that is from the severe accident management measurements) will be available on the technological parameters after the rundown of the batteries (about 4 hours).

The availability of the dosimetrical measurements is essential, since they can be directly applied to evaluate the situation when the other pieces of information (i.e. temperatures, pressures, levels, etc.) are lost; on the other hand the ERO needs information on radiation conditions during the planning of the response actions. The ERO is prepared to install temporary dosimetry measurements on the yard and other locations where it is required.

6.1.3.9. Management of a multi-unit extended accidents

The emergency response tasks to be performed in the case of a multi-unit accident (i.e. response to a beyond design basis accident) were reviewed in the frame of the re-assessment. Under such circumstances certain tasks cannot be performed individually by the ERO, its resources have to be completed.

When the multi-unit accident is a consequence of the permanent loss of electrical power supply or of the ultimate heat sink, so that the evolved situation cannot be recovered before the units turn to severe accident states, sufficient time is available for the ERO to perform certain tasks.

- The evacuation does not require extra resources, since the same number of persons has to be evacuated as in the case of the accident of a single unit. The fundamental principle is that the evacuation has to be realized, if possible, before the radioactive materials are released. Adequate plans have to be implemented for the evacuation; the necessary resources are available.
- The alerting and information activity does not require extra resources in comparison to events that are within the design basis (the same tasks have to be performed; only the content of the text is changed).
- The long term availability of operating, maintenance (restoration), dosimetry and expert personnel can be assured by regrouping and effective use of own resources even in the case of a multi-unit accident.

Plans do not exist currently at Paks Nuclear Power Plant, which aim to provide tools and resources for the response to a multi-unit accident. In the case of a multi-unit accident, the emergency response tasks have to be performed with the help of the national competent organizations.

- The technical arrangement of the Technical Support Centre, with the development of the staff number, makes possible to manage the severe accidents of two units simultaneously. If all experts potentially involved at the Technical Support Centre participate in the response, then no more experts remained for subsequent changes. The instrumentation and physical arrangement of the Technical Support Centre installed at the Protected Command Centre are currently not applicable to manage severe accidents of all four units.
- In the case of a multi-unit event, the need for the involvement of external resources is expected to the execution of fire fighting, technical rescue, medical and security tasks, since the plant resources are not sufficient for the management of such an extended accident.
- If the accidents occur simultaneously on each unit, and the external electric power supply and the safety electrical power supply fail, then only those systems remain operable, which have individual supply from mobile diesel generators. The lack of lighting, and the limited operability of wire and wireless communication systems will hinder the interventions. The plant has to be prepared for the temporary establishment of the necessary communication systems.

6.1.4. Organizational issues for accident management

The Paks NPP Ltd generally possesses all personal and material conditions and resources that are needed for the response to emergencies (both nuclear and conventional emergencies). The emergency and severe accident intervention ability was established in compliance with the requirement of internal recommendations and national regulations. The intervention capacity, in the time of preparation, is provided by the stand-by systems and instruments and by the organization that can be alerted. In normal situation the obligatory inspection, training and exercising system maintains the intervention capacity of the plant.

The ERO of the Paks NPP starts its operation after the declaration of the emergency. The ERO is operated in line with the national regulations and plant level internal procedures. The design basis of the ERO includes the design basis accidents and the severe accidents, the loss of the electrical

power supply and/or the essential service water system, and such extreme external events that lead to simultaneous accidents of all four units.

The re-assessment demonstrated that the ERO is prepared and ready for the management of design basis events; however, its conditions can be further improved by certain measures. The simultaneous accident of all four units, as a consequence of the loss of electrical power supply and/or essential service water evolves relatively slowly, thus the situation extended to all units can be managed by the ERO with the involvement of external forces. Certain external events beyond the design basis would cause such person and material loss, the response to which requires the contribution of national competent organizations.

The re-assessment paid special attention to the involvement of external support forces required for emergency response (i.e. available capacities, transportation opportunities). The cooperation with external forces is adequate and well regulated.

6.1.5. Measures which can be envisaged to enhance accident management capabilities

The measures aimed to improve the emergency management capabilities are as follows:

19. The not yet qualified protection shelters have to be qualified to earthquakes; the non earthquake resistant equipment of the shelters have to be reinforced.
20. Such Backup Command Centre has to be established in compliance with the protection requirements (i.e. regarding earthquake, radiation, environmental temperature, etc.), which is equivalent to the Protected Command Centre regarding its control and communication instrumentation. The air conditioning of the Protected Command Centre has to be reviewed, and such a machine having adequate capacity has to be established, which is able to operate from electrical power supplied by mobile diesel generators.
21. The rules for lifting flying ban around the plant have to be modified in order to allow air transports required for emergency management.
22. In connection with severe accident management, those tools have to be purchased, which are needed for the establishment of the external power supply route to the auxiliary emergency feedwater system and for the connection of mobile diesel generators and pumps obtained from external sources.
23. Procedures have to be developed for the management of liquid radioactive wastes during severe accidents.

6.2. Accident management measures in place at the various stages of a scenario of loss of the core cooling function

The modifications implemented at Paks NPP with regard to severe accident management are aimed to stop any assumed severe accident event sequence and to bring the unit to safe cold state. Two key elements of the practical execution of severe accident management are the execution of the technical modification belonging to SAM and the introduction of Severe Accident Management Guidelines (SAMG). The principal elements of severe accident management modifications are as follows:

- external cooling of the reactor pressure vessel by discharging water from the localization tower and flooding the reactor cavity,
- severe accident management measuring system,
- severe accident diesel generators for supplying electrical power to SAM instruments,
- hydrogen management under severe accident conditions by passive autocatalytic recombiners,
- prevention of coolant loss from the spent fuel pool due to pipeline rupture.

Based on the SAMG the processes entailing significant radioactive releases (from the reactor or the spent fuel pool) during severe accidents occurring in any service state of the unit can be managed. The strategy is aimed to bring the unit to a controlled and stable state and to avoid the release of fission products.

6.2.1. Measures before fuel damage in the reactor pressure vessel

In the case of total blackout and/or the loss of the ultimate heat sink, primary pressure is high in the early stage of the process; therefore the most important function is the reduction of the pressure. Prior to the evolution of extensive core damage, the pressure reduction is made according to the Symptom-oriented Operating Procedures.

6.2.2. Measures after fuel damage in the reactor pressure vessel

At first the external cooling of the reactor pressure vessel requires water discharge from the localization tower (from the bubble trays) to the floor of the containment, and then the water can be discharged to the reactor cavity from there by the force of gravity. The about 1180 m³ water and the coolant from the primary circuit can be used to fill up the 270 m³ reactor cavity. The electrical power of the discharge valves can be provided from the normal, safety and severe accident power supplies. The discharge of water from the localization tower has to be started before the evolution of extended core damage, when the core outlet temperature reaches 550 °C. The discharge valves can be operated, if the primary pressure is lower than 20 bars and the water level on the containment floor reaches a given level (see Figure 6-1). The execution of all the above mentioned measures requires operatory interventions pursuant to the "Water supply to the hermetic compartments, flooding of the reactor cavity" instruction.

Since the water is discharged from the localization tower to the containment floor by the force of gravity, and the discharge valves can be operated with the use of the severe accident diesel generator, these accident management actions can be executed even in the case of total blackout and/or loss of the essential service water system. The water transfers the heat from the wall of the reactor pressure vessel (in the way of boiling and condensation) to the containment through natural circulation, and thus the reactor pressure vessel is protected and the core debris and molten parts are cooled within the reactor pressure vessel.

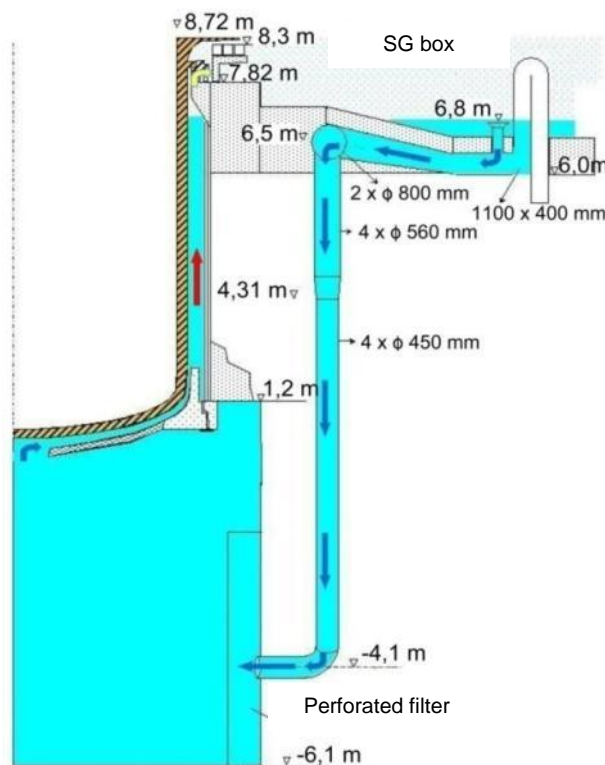

Figure 6-1: Scheme in principle of the external cooling of the reactor pressure vessel

According to calculations made on the external cooling of the reactor pressure vessel, the stable cooling is assured based on the natural circulation of the coolant; consequently, the intactness of the reactor pressure vessel can be maintained. The conclusions drawn from the calculations were justified by the modelling of the heat flux occurring during the accident and the actual geometry of the reactor cavity in the frame of CERES experimental analyses conducted in Hungary.

6.2.3. Measures after failure of the reactor pressure vessel

According to the above paragraph, damage to the reactor pressure vessel is not expected. In spite of the measures described above should vessel damage happen, then in principle it may occur in two situations: before flooding the reactor cavity and after it. In the first case the experts of the Technical Support Centre have to decide on whether the flooding of the reactor cavity after the damage to the vessel is to be performed, based on whether the debris can be cool down. On the other hand, steam explosion may occur if too much water is used. In the second case if the reactor pressure vessel suffers damage after the flooding of the cavity, then a relatively small amount of molten fuel will escape and then the solidifying debris will block the route.

6.3. Maintaining the containment integrity

Potential mechanisms causing damage to the containment of the Paks NPP are as follows:

- reactor pressure vessel damage under high pressure and sudden pressure peak occurring in the reactor cavity, which may cause extensive containment failure,
- hydrogen burning induced sudden pressure increase, which may entail containment failure,
- ex-vessel steam explosion after reactor pressure vessel damage, which may cause containment failure;
- interaction between the molten core and the concrete after reactor pressure vessel damage, which entails basemat melt-through and containment damage,
- containment rupture caused by slow over pressurization.

The available solutions to prevent and manage such situations are described below.

6.3.1. Elimination of fuel damage/meltdown on high pressure

In the case of total blackout and/or loss of the ultimate heat sink, the primary circuit pressure is high in the initial phase of the process. The reduction of the pressure is important because: certain elements of the emergency core cooling system can start to operate only on lower pressure level, and the consequences of any damage to the reactor pressure vessel on high pressure have to be avoided by any means. The Symptom-based Operating Procedures give instruction on unconditional pressure reduction above 550°C core outlet temperature with the assumption that all attempts to restore the cooling of the core were unsuccessful. If the core outlet temperature further increases during the application of the Symptom-based Operating Procedures and then exceeds the value of 800 °C in the case of total blackout, or the value of 1100 °C in any other case, then the SAMGs have to be applied. The SAMGs include new instructions to reduce the primary pressure with all available means. The most important means of pressure reduction are described in Sections 6.2.1 and 6.2.2.

6.3.2. Management of hydrogen risk inside the containment

The 60 (30 pairs) NIS type passive autocatalytic severe accident recombiners installed for hydrogen management in the containment significantly reduce the quantity of hydrogen generated during the analysed severe accident processes. Even if the hydrogen generation due to zirconium water reaction can be such intensive in certain processes that in spite of the recombiners the hydrogen may burn during an initial short period of time. The concentration of hydrogen is low enough that the hydrogen burning cannot jeopardize the integrity of the containment. In later phase of the severe accident process the hydrogen concentration further decreases, and thus the gas mixture is not

flammable anymore. The operation of the hydrogen recombiners is based on physical and chemical principles, thus intervention is not required. Consequently, the relevant instructions of the SAMGs primarily focus on the monitoring of the hydrogen concentration. The hydrogen leaks to the reactor hall and the technology building through the permissible leakage of the containment. Burnable gas composition cannot develop in these rooms, the hydrogen concentration remains below 1 vol%.

6.3.3. Prevention of overpressure of the containment

After the flooding of the reactor cavity, the residual heat of the molten core in the reactor pressure vessel, by heat transfer through the wall of the vessel, warms up the coolant in the cavity. The evaporation of the coolant increases the quantity of steam in the containment; if the sprinkler system is not operable, the containment pressure will gradually increase.

The evolution of containment pressure during the characteristic severe accident process, after further flooding of the vessel, as a function of different leakage rates, is shown in Figure 6-2. The permitted leakage rate of the containment is 14.7 vol%/day; the actual leakage rates of the units are smaller (the actual values are in the range of 4-8 vol%/day). As seen, the long term evolution of pressure is highly dependent on the actual value of the containment leakage rate. Nevertheless, it can be concluded that if intervention is not implemented to reduce it, then sooner or later high pressure will occur in the containment.

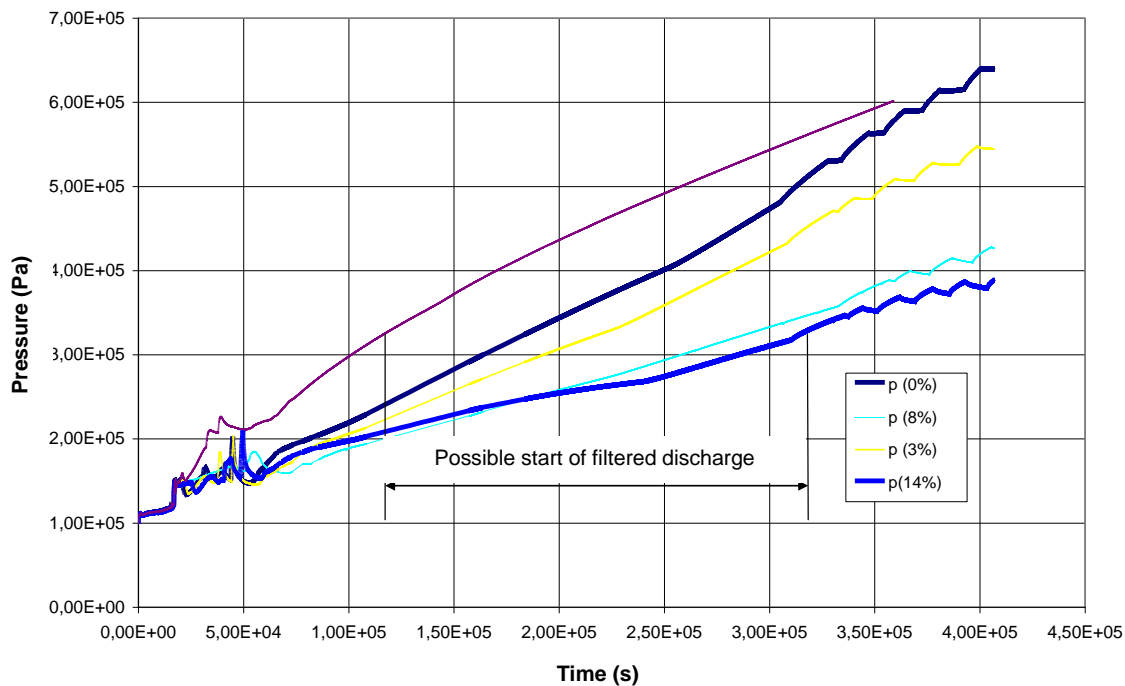

Figure 6-2: Pressure in the containment (reactor cavity is flooded) at different leakage rate values

The HCLPF value (3.35 bars absolute pressure) is the determinant with regard to avoid damage and timeliness of the intervention. As it is shown in Figure 6-2, depending on the containment leakage rate, the containment pressure exceeds the value of 3.35 bars within 3-8 days. If pressure reduction does not occur in the meantime, the containment pressure will increase until the containment will fail or until the mass flow leaking from the containment will be equal to the generated mass flow.

The slow overpressure is caused by steam produced during the external cooling of the reactor pressure vessel. Consequently, the relevant accident management guideline requires the reduction of the pressure in the containment. The pressure reduction can be achieved by cooling of the air volume or by relieving the containment pressure through the venting system. If the electrical power supply is totally lost, then the air volume cannot be cooled by design tools; the only possibility is to discharge air through the venting system of the containment; thus damage to the containment can be avoided. Based on the analyses, the reduction of the pressure in the containment becomes necessary

after 3-8 days. At that time the fission products (with the exemption of the noble gases) deposit on the walls of the containment or settle down to the water on the floor of the hermetic compartments.

Nevertheless, unfiltered release can be executed only after the evacuation of the area around the nuclear power plant; thus further corrective measures are identified to manage the prevention of containment overpressure, which will be realized in the next phase of the severe accident management modifications. Further concepts are on the table in this regard. One concept aims at the filtered discharge of the containment, when the radioactive air is released from the containment through a filter having adequate efficiency. Another concept aims at the long term cooling of the containment that also handles the containment overpressure and makes the filtered or unfiltered discharge from the containment unnecessary. The SAMGs have to be updated after the finalization of the above mentioned technical solutions and the implementation of the required modifications.

6.3.4. Prevention of re-criticality

A basic and high priority intervention of severe accident management is the flooding of the damaged or molten core, when any flooding capability can be put into service or restored. The potential re-criticality of the core has to be assessed; the re-criticality of the core was analysed in two extreme situations occurring in various phases of severe accident event sequences as follows:

- In the phase when the boron steel absorbents melt, while the fuel assemblies remain in unchanged geometry, and the re-flooding of the intact reactor pressure vessel takes place.
- In the phase when the fuel assemblies melt in the core, and in a certain moment they are flooded with water having different boron content (this scenario was analysed in four phases).

The following statements can be concluded from the analyses:

In the first case, when only the absorbents melt in the core, the core can be cooled by water having a boron acid content of at least 12 g/kg, without the risk of re-criticality.

In the second case, the extent of porosity and the penetration of water to the corium are determinant factors regarding the multiplication factor of the molten core. If the porosity is smaller than 15% or if the water cannot penetrate the corium, then re-criticality cannot be expected even if the core is cooled with water having no boron acid content. The uncertainty of the results is caused by the uncertainty of the geometry and composition data of post-melting configurations.

It is not permitted to feed water having lower boron acid concentration than that of the water in the containment to the reactor pressure vessel, if the condition of the core is unknown after the accident, because it may make the system critical again. Consequently, the boron content of the coolant to be supplied to the containment has to be increased; the boron concentration has to reach as minimum the value specified for the tanks of the emergency core cooling system. A corrective measure was identified to increase the boron concentration of coolants supplied from alternative sources to the containment.

6.3.5. Prevention of basement melt through

After the damage to the reactor pressure vessel, an interaction will start between the molten core and the concrete basement of the containment that is caused by the corium fell into the reactor cavity. The molten core can be kept within the reactor pressure vessel by flooding of the reactor cavity and external cooling of the vessel. Damage caused by the core-concrete interaction may appear only if the accident management measures become unsuccessful; nevertheless due to the constructional arrangement of the accident management system (passive operation, redundant solutions of water discharge) this shall not be assumed.

6.3.6. Tools and resources used for protecting containment integrity

Independently of the safety electric power supply system, one severe accident diesel generator is available on each unit that is capable (in the case of total blackout) to supply electrical power to those measuring, control and intervention systems, which can be used to perform the actions aiming

at the prevention and mitigation of the consequences of the severe accident (i.e. reduction of pressure in the primary circuit, flooding of the reactor cavity, relief of the steam generators within the hermetic compartments).

The execution of severe accident management instructions aiming at the protection of containment integrity requires no other power source (e.g. compressed air), but the severe accident diesel generator. The hydrogen recombiners are independent of any power source.

6.3.7. Measuring and control instrumentation needed for protecting containment integrity

Certain primary circuit and secondary circuit parameters are required to be known for the execution of interventions defined in the Severe Accident Management Guidelines; thus the severe accident measurement system is an important element of the severe accident modifications. The principal elements of the measurement system are as follows:

- primary pressure and core outlet temperature,
- containment pressure, temperature, oxygen and hydrogen concentrations,
- water levels in the containment, reactor cavity and spent fuel pool,
- doses rates inside and outside the containment.

The construction of the measurement system guarantees its operability under severe accident conditions (temperature, radiation, humidity). Batteries can supply electrical power to the measurement system for 3.5 hours. This period is sufficient to put the severe accident diesel generators into operation, then to start them; these severe accident diesel generators supply electrical power to the system.

6.3.8. Management of multi-unit severe accidents

A basic principle applied to the Severe Accident Management Guidelines is that each available system can be used during the management of the accident process. The SAMGs refer to the alternative use of systems of the twin-unit, which is naturally not possible in the case of a multi-unit accident. The resources and the accident electrical energy supply of the dedicated accident management system were installed individually on each unit; thus the management of severe accidents occurring on different units is made independently of each other, and the management of multi-unit accidents is solved from technical point of view. On the other hand the simultaneous accident management on more than one unit means increased organizational tasks that the personnel have to perform.

The available analysis results cannot fully exclude the evolution of flammable hydrogen concentration based on the quantity and distribution of hydrogen produced during simultaneous accidents of two spent fuel pools of an installation, an open reactor under refuelling and a closed one under operation. The reliable assessment of this issue requires less conservative, three-dimensional calculations.

6.3.9. Conclusion on the adequacy of severe accident management systems for protection of containment integrity

The severe accident management modifications at the Paks NPP are aimed to stop the processes anticipated after an assumed severe accident and to bring the unit to safe cold state. Two key elements of severe accident management are the introduction of the instructions given in the Severe Accident Management Guidelines and the execution of the associated technical modifications.

The severe accident management is independent of the units; thus it can be applied even in the case of fuel damage occurring in four reactor pressure vessels at the same time.

The systems required for the simultaneous management of fuels stored in the spent fuel pool and in the reactor pressure vessel are available, but the guideline on the use of resources is not yet prepared; it has to be developed in the near future.

An already known issue regarding extensive emergency management is the slow over-pressurization of the containment. A corrective measure was identified in this regard.

6.3.10. Measures which can be envisaged to enhance capability to maintain containment integrity after occurrence of severe fuel damage

The extensive processes of severe accident management (i.e. those to be performed after one week) have to be analysed. The system (filtered discharge, containment internal cooling) aiming at the prevention of the slow over-pressurization of the containment has to be designed and installed accordingly.

6.4. Accident management measures to restrict the radioactive releases

6.4.1. Radioactive releases after loss of containment integrity

The processes causing damage to the containment of the Paks NPP are discussed in details in Section 6.3. It can be seen how the accident management can effectively hinder those processes that may cause failure of the containment integrity. The potential slow over-pressurization evolves during such a long time that the probability of containment failure is very low even in such a case. During the slow increase of pressure, if means are not available to reduce the pressure, the unfiltered release through the stack on this monitored and controlled way is more advantageous than through the damaged containment. Due to longer available period of time, the potentially required evacuation can be executed.

6.4.2. Accident management after uncovering of the top of fuel in the fuel pool

The consequence mitigating accident management to be executed subsequent to a severe accident of the spent fuel pool is not yet prepared. If the cooling of the spent fuel pool in normal operating mode and/or the execution of preventive accident management interventions would be successful only after core uncovering, then the interventions being developed will be applicable to mitigate the consequences.

The blown or potentially in hermetic, but not yet severely damaged fuel assemblies may degrade further because of flooding of the core (the water does not necessarily stop the melting process); the assemblies may break up to pieces, but this step is essential for the reduction of the radioactive release.

The boron acid concentration of the coolant flooding the fuel assemblies has to be set high. Reaching the nominal 13.5 g/dm^3 value is anyway necessary but not always sufficient. Criticality accident may occur in special geometry configurations only; their risk is not that high to obtain the first priority from the reduction of the radioactive release among the interventions. Consequently, the flooding of the spent fuel pool with coolant containing boron acid in at least 13.5 g/m^3 concentration has to be started as soon as possible.

6.4.3. Conclusion on the adequacy of measures to restrict the radioactive releases

The modifications implemented at Paks NPP with regard to severe accident management are aimed to stop any assumed severe accident event sequence and to bring the unit to safe cold state. Two key elements of the practical implementation of severe accident management are the execution of the technical modifications belonging to SAM and the introduction of Severe Accident Management Guidelines. The principal elements of severe accident management modifications are as follows:

- external cooling of the reactor pressure vessel by discharging water from the localization tower and flooding the reactor cavity,
- severe accident management measuring system,
- severe accident diesel generators for supplying electrical power to SAM instruments,
- hydrogen management under severe accident conditions by passive autocatalytic recombiners,

- prevention of coolant loss from the spent fuel pool due to pipeline rupture.

The introduction of severe accident management significantly reduces the probability of large radioactive releases; it is expected that this value will not exceed the more strict requirements for new-build units.

The severe accident management is independent of the units; thus it can be applied even in the case of fuel damage occurring in four reactor pressure vessels at the same time. The systems required for the simultaneous management of fuels stored in the spent fuel pool and in the reactor pressure vessel are available, but the guideline on the use of resources is not yet prepared; it has to be developed in the near future.

If the accident management is extended to a longer period of time, then slow overpressurization of the containment may occur. The concept on protection against this phenomenon will be developed and realized in the next phase of the accident management modifications.

7. General conclusion

The most important result of the Targeted Safety Re-assessment is that it has not revealed any such deficiency at Paks NPP, which may question the adequacy of its design basis and may require any urgent regulatory intervention.

In fact, this result is not surprising, since several comprehensive reviews were conducted in 1996-1998 and 2007-2008 in the frame of the Periodic Safety Reviews (PSR) that are required to be performed every ten years. The main objective of a PSR is to assess the safety of the plant with respect to the state-of-the-art, and to identify the risk related to the possible non-compliances. The implementation of the action plan developed as a result of the PSR aims at the reduction of this risk to the acceptable level.

It should be highlighted that Paks NPP Ltd, in certain regards, partly as a consequence of the requirements issued by HAEA, went to meet the stress test (TSR) expectations years ago. The most important item to be highlighted is the seismic safety review and the subsequent reinforcement programme that have launched in the 1990's. This programme has been fully completed by now. Another important item is the severe accident management project. The related programme is in progress for years; many of its outcomes have been already realized. The completion of the programme is a condition required by HAEA for life time extension; accordingly the programme will be completed in 2012 on Unit 1, and in the other units according to the approved schedule. In this regard, the units of the Paks NPP, by the realization of the severe accident management programme, reach the capabilities of the units being currently under construction.

In the light of the Fukushima experience, the TSR conducted by the plant has revealed certain potentials and circumstances, the deployment of which or modification in a better direction will further reduce the risks and consequences of beyond design basis situations. In other cases it could be decided, based on detailed considerations and analyses, whether any further modification is reasonable. A part of the modifications has technical nature, while the other part relates to organizational issues.

A part of the recommended measures aims at the qualification of certain civil structures and facilities, which do not have direct nuclear safety function, but their potential failures may hinder the general rescue activity in a situation occurring subsequent to a major earthquake, or may indirectly jeopardize a safety equipment. The technical recommendations primarily aim at further improvement of the electrical power supply system by diverse generators (in addition to the 3 emergency diesel generators available on each unit), and the deployment of alternative water sources to remove heat from the shutdown reactors. Several less significant modifications are also listed among the recommendations, which can further improve the availability of safety systems in a severe accident situation; the establishment of certain connections (electrical power and coolant) can enhance the flexibility of accident management provisions.

Though the extreme environmental effects experienced at Fukushima and the occurrence of the subsequent severe accident event sequence is highly improbable at the Paks site, it cannot be completely excluded that severe accident management procedures have to be applied on more (or even all) units due to an external effect significantly beyond the design basis. Consequently, this can be considered as the single direct lesson learned, which can be deployed by Paks NPP Ltd for the further improvement of the plant safety.

7.1. Key provisions enhancing robustness (already implemented)

The probabilistic safety analyses show an overall positive picture of the current state of the nuclear power plant. The essential part of the severe accident management modifications have been already completed on Unit 1, and they are in progress on other units. The scope of the analyses, as in other nuclear power plants, is continuously extended (as in the past) based on the accumulated operational experience and the most recent scientific results.

It was concluded from the formerly conducted periodic safety review that the loads and conditions caused by meteorology originated hazards (being much more critical than an earthquake), which cannot be completely excluded (based on the frequency) from the design basis of certain systems, are not systematically documented. Therefore the following corrective measure being under implementation was identified as a result of the previous PSR:

"The site characteristics and loads induced by hazards having various natural origins have to be determined for those events being less frequent than the design basis within the frequency range 10^{-4} - 10^{-7} 1/year. The potential consequences have to be assessed of each event causing loads above the design values, and the potential risk contribution of each event has to be calculated."

The task formulated in the first sentence of the above corrective measure has been completed; its results are described in Section 1.2.2. The task of the second sentence will be completed by a PSA analysis (currently in progress), which relates to environmental effects other than earthquakes.

Another corrective measure to be highlighted, being in close relation to the previous one, relates to the external hazards: "the scope of those systems and civil structures has to be identified, the design basis of which has to include the effects of certain external hazards. The affected safety functions and the way how they are affected by the external hazard have to be systematically recorded with regard to these systems and civil structures, and then the adequacy of the demonstration of the compliance with the design basis (as described in the relevant PSR chapter) has to be verified."

A thorough analysis and modification project was launched in 2008 to mitigate the consequences of accidents beyond the design basis, which have low probability but lead to severe damage to the reactor core (so called severe accidents). As a result of the project, several technology modifications needed for the introduction of the severe accident management actions have been already realized at the Paks NPP; however the completion is in different stage on the different units. The current states of the completion of the actions are summarized in Table 1-2.

7.2. Safety issues, "cliff edge" effects

The analysis made in the frame of the Targeted Safety Re-assessment has not revealed such condition, which may lead directly to the occurrence of a cliff edge effect. Based on the new hazard assessment (see Section 5) made with the use of former analyses and the freshest available meteorological data, it can be concluded that such meteorological event is not known currently, the occurrence of which may induce drastic degradation in the load factors leading to sudden damage; thus no occurrence of any cliff edge effect can be assumed.

According to Section 2 evaluating seismic hazard, the safety margin against extensive soil liquefaction is small. This statement was concluded from the analyses of the design basis earthquake made by simplified empiric and semi-empiric methods, and according to the methodology applied in PSA. The determinant failure mode in the acceleration range above the design basis is the soil liquefaction inducing building settlement. The settlement and the relative movement of buildings and cables (installed in the unloaded soil) exceed the recently assumed values. Consequently, the analysis of this effect is essential to demonstrate the capability to avoid the cliff edge effect. The phenomena of building settlement and soil liquefaction have to be further analysed in order to adequately design those measures, which prevent the failures caused by building settlement and make greater relative movement of cables possible.

According to Section 2 evaluating seismic hazard, the safety margin against soil liquefaction is relatively small. This statement was concluded from the analyses of the design basis earthquake made by deterministic simplified empiric and semi-empiric methods. This conclusion has been provided by the seismic PSA partially due to the conservative assumptions made regarding soil liquefaction. In spite of essential uncertainties, the dominating failure modes in case of beyond design basis earthquakes are related to the building settlement due to soil liquefaction. The settlement and the relative movement of buildings and some cables installed in the unloaded soil

may or may not exceed the recently assumed values. Consequently, the further analysis of the building settlement is essential for demonstrating the beyond design base capability of the plant to escape the cliff edge effect. The phenomena of building settlement due to earthquakes with and without soil liquefaction has to be analysed in order to better characterisation of the phenomenon, identification and adequately design of the measures, which can prevent the failures caused by building settlement and ensure greater relative movement of cables.

7.3. Potential safety improvements and further work forecasted

7.3.1. Measures envisaged to further increase of safety

The summary below specifies those areas, development directions revealed by the Targeted Safety Re-assessment for which safety improvement measures have to be implemented. The authority will assess the deadlines for the implementation in separate regulatory procedures after the detailed task plans will be available and will then order for the implementation of the measures, as appropriate.

Increase of robustness against external hazards (earthquake, flooding)

1. In order to improve the seismic safety, some of the currently unqualified reinforced concrete buildings have to be qualified and reinforced, as necessary, even though they are not directly safety related. Within the scope of this task the seismic qualification of the 400 kV and 120 kV substations, fire brigade barrack, shelters at the site and non-earthquake resistant equipment in the shelters will be improved. The demineralised water tanks of Installation II (unit 3 and 4) have to be protected against the possible impact from the falling-down walls of the service building over the tanks. The necessity of implementing an automatic reactor shutdown function during the planned modernisation of seismic instrumentation will be re-investigated. Proper fixing of the tools and appliances used during the outages and stored at the units has to be ensured for avoiding any adverse impact with safety equipment due to an earthquake.
2. Measures to avoid failures originating from building settlement caused by an earthquake have to be identified. A state-of-the-art analysis has to be performed for the proper assessment of the existing margins of earthquake-initiated building settlement and soil liquefaction phenomenon. The affected underground lines and connections have to be re-qualified or modified to allow for a relative displacement.
3. Adequate protection has to be installed to stop the main condenser coolant pumps when the main condenser coolant pipeline damages. It has to be ensured that the pipeline trenches are suitable to receive and drain the discharged water. If necessary, the slope has to be elevated or a protective dam has to be constructed to avoid the flooding of the turbine hall or the cable tunnels. In the machine room of the essential service water system pumps the penetrations of the machine room wall has to be modified to water sealed design.

Further improving measures specified by HAEA

4. It has to be analyzed if the lack of seismic qualification of the filter structures (machine racks and travelling water band screens) of the essential service water system may jeopardize the ultimate heat sink function and, if necessary, the adequate measures have to be implemented.
5. The database containing seismic safety classification of the components has to be reviewed to provide that the classification is in agreement with the information given in the licensing documentation of seismic safety improvement modifications.
6. A list of such system components important to safety, which are endangered by electromagnetic effects (including the effects induced by lightning) and thereby needs to be classified accordingly, has to be compiled to display whether or not a given component is adequately qualified.

Modification of existing and development of new procedures

7. Existing plant operating procedures have to be amended or new ones have to be created in order to improve the margins and to utilise better the current options for restoration. During these modifications, the amount of diesel fuel to be stored at the plant shall be increased and the quantity of demineralised water stored in the tanks shall be maximised. The periodic inspection and maintenance of equipment stocked for coping with low water levels of Danube has to be controlled. Operating procedures need to be developed for the utilisation of alternative, previously unused, on-site cross-connections between the normal, backup and safety bus-bars. The existing symptom-based emergency operating procedures shall be reviewed to make sure that they support optimal recovery from the simultaneous occurrence of an earthquake and a primary circuit pipeline break. Liquid radioactive waste management procedures have to be developed for severe accident situations and the severe accident management guidelines have to be developed for managing and addressing simultaneous accidents in the reactor and the spent fuel pool.

Provision of existing and alternative electric supply options

8. Diverse diesel generators have to be installed to support the power supply of safety consumers that have a role in preventing severe accidents and/or managing an accident in the long term. The number and capacity of these diverse diesel generators has to be adjusted so that they are capable of supplying consumers, pumps and isolation valves of all reactors and spent fuel pools at the same time even during the loss of power supply in all units. The diverse diesel generators have to have appropriate protection against beyond design basis external hazards (earthquake, natural hazards, flooding) of the installed emergency diesel generators and they have to be totally independent of other systems (such as the cooling or electric supply systems) of the plant.
9. Black-start capability (start-up from own diesel generator) has to be created for the Litér gas turbine, which can provide external electrical power via a dedicated transmission line.
10. Possible cross-links have to be developed for providing safety electrical power supply at 6 kV from any operable emergency diesel generator of any unit to the safety consumers of any other unit when off-site power is lost. All necessary design modifications have to be implemented.

Provision of existing and alternative cooling options

11. In order to avoid clogging of the intake filters of the essential service water system, the electric power supply of the filters has to be changed to safety electric supply.
12. In order to provide long-term heat removal through the steam generators, the possibility has to be established for feeding external cooling water from the already existing connection points in the yard area via existing injection lines to the auxiliary emergency feedwater system. Accessibility of the external connection points under accident circumstances has to be improved. The connection points may need to be relocated. As water stored in the demineralised water tanks can be used as an alternative water source during an accident, appropriate connection points on these tanks have to be installed for providing water to the auxiliary emergency feedwater system using mobile pumps. Arrangements have to be made for the utilisation of additional water sources such as the Danube and the fishing lakes near the plant. The necessary equipment has to be provided for connecting mobile generators and pumps delivered from outside the site to the process equipment. Plant procedures have to be prepared for the utilisation of such external tools.
13. The opportunity to feed cooling water directly into the containment through the auxiliary emergency feedwater system and the recently installed secondary side blow-down valves of the steam generators is given, but only borated water should be used for that purpose. Using the

existing tank park, the method to borate and store of borated water has to be provided. The method of water supply into the containment from external sources has to be specified in procedures.

14. An alternative way of supplying external cooling water to the spent fuel pools from a yard area connection point, suitable for flexible hose connection, has to be implemented. The water supply route need to have appropriate capacity and qualified for the anticipated external conditions.. In an accident situation, should there be no other option, the spent fuel pool has to be filled from the borated water reserves specified above. The required operations have to be specified in procedures.
15. Dedicated electric power supply has to be provided for emergency situations by duly protected fixed or mobile diesel generator to supply the submersible pumps of the nine large-diameter wells, drilled into the pebble bed of the Danube bank.
16. The additional cooling water source of $\sim 2 \times 2,000 \text{ m}^3$ has to be made available from the closed section of the discharge water canals for the nearby, diesel-driven fire water pump station of Installation II which can remain in service for approximately 8 hours.
17. The different methods of cross-connecting the fire water and the essential service water systems in the various units have to be unified. (In Installation I, feeding fire water via the normal service water system into the essential service water system is readily available. The same solution has to be provided for the systems in Installation II)
18. The necessary tools and procedures have to be provided to start and cool at least one emergency diesel generator per unit from the alternative source of coolant from the fire water system of the building. The operations to provide the water supply have to be included in procedures.

Further improving measures specified by HAEA

19. For the close reactor state, when the primary temperature is under $150 \text{ }^\circ\text{C}$ a probabilistic safety analysis has to be performed to assess whether it is reasonable establish and introduce a time limit considering the balanced distribution of risk.

Mitigation of severe accident consequences

20. In order to determine the quantity and distribution of hydrogen in the reactor hall during an accident that simultaneously assumes two damaged spent fuel pools and two (one open and one closed) damaged reactors within a twin unit, less conservative, three-dimensional analyses have to be carried out beyond the use of the lumped-parameter models.
21. An analysis of the long-term (beyond 1 week) progression of severe accidents has to be carried out to mitigate the severe accident consequences. Based on the analysis results, appropriate measures that is suitable to prevent the long-term, slow over-pressurisation of the containment (filtered venting, internal containment cooling) has to be developed and implemented.
22. The on-site management of consequences of uncontrolled key events, especially of multi-unit accidents, has to be improved. For this purpose the Backup Command Centre has to be protected against earthquakes, radiation, external temperature, etc., and equipped with the same controlling and communication capabilities as those at the Protected Command Centre. Air conditioning of the Protected Command Centre has to be revised and new equipment with proper capacity has to be installed with a backup diesel power supply. The prerequisites of communication have to be identified for long-term loss of electricity and earthquakes and any necessary measures have to be taken. Mirror computers with all necessary data (i.e. designated plant documentation, personnel data, etc.) have to be deployed in both the Protected Command Centre and the Backup Command Centre. Procedures for collecting and transporting ERO

personnel have to be developed and the necessary means and rules of their provision have to be determined. A shielded transport vehicle deployable at significant radiation levels has to be procured. The rules for exemptions from the air ban around the plant have to be modified to manage airborne support. A software-based severe accident training simulator has to be developed. The layout and the instrumentation of the Technical Support Centre in the Protected Command Centre will be extended to manage simultaneous multi-unit accidents. The structure and strength of the organisation that assists in emergency protection also during a multi-unit accident has to be determined and the corresponding rules for providing personnel and equipment and for shift changes have to be drawn up.

7.3.2. Evaluation of safety after implementation of the proposed improvement measures

The authority finds it justified to implement the measures listed above to increase the safety margins. Considering that the achievement of the initiated objectives improving the margins requires the performance of complex tasks, the authority is going to order for preparation of task plans that will contain the detailed specification of each task and the respective deadline. The authority intends to assess the task plans on an individual basis and is ready to revise the deadline, as appropriate. Basic aspects in the implementation of the tasks are the time demand of implementation and the effectiveness of the improvement measure.

The authority agrees with Paks Nuclear Power Plant regarding the assessment of the safety of the plant after full performance of the proposed safety improvement measures:

- The probability of a severe accident due to long-term loss of electricity or of the ultimate heat sink function will further decrease compared to the already small value.
- By ensuring an alternative water supply and alternative electric supply options, any former severe accident situation of the spent fuel storage pool becomes appropriately manageable.
- Extreme external events may still result in damage at the site but the safety consequence of the damages will be further reduced.
- The already very low probability of multi-unit accidents will become even smaller and, in parallel to that the range of emergency response solutions will be extended, whereas the activities will become more regulated and grounded.

References

- [1] Declaration of ENSREG - EU "Stress Tests" specifications, 13 May 2011
<http://www.ensreg.eu/node/286>
- [2] Requirements for the content of the Targeted Safety Re-assessment (TSR) of Paks Nuclear Power Plant (CBF), HAEA, May 24, 2011.
[http://www.haea.gov.hu/web/v2/portal.nsf/att_files/brochur/\\$File/CBF%20elvárások_v5.pdf?OpenElement](http://www.haea.gov.hu/web/v2/portal.nsf/att_files/brochur/$File/CBF%20elvárások_v5.pdf?OpenElement)
- [3] Targeted Safety Re-assessment, Progress Report, Paks Nuclear Power Plant Ltd., August 15, 2011. [http://www.oah.hu/web/v2/portal.nsf/att_files/brochur/\\$File/CBF_EJ.pdf?OpenElement](http://www.oah.hu/web/v2/portal.nsf/att_files/brochur/$File/CBF_EJ.pdf?OpenElement)
- [4] Preliminary National Report on the Targeted Safety Re-assessment of Paks Nuclear Power Plant, HAEA, September 14, 2011.
[http://www.oah.hu/web/v2/portal.nsf/att_files/brochur/\\$File/CBF_E_NJ_alairt.pdf?OpenElement](http://www.oah.hu/web/v2/portal.nsf/att_files/brochur/$File/CBF_E_NJ_alairt.pdf?OpenElement)
- [5] Technical Summary of the national progress reports on the implementation of comprehensive risk and safety assessments of the EU nuclear power plants, November 24, 2011, SEC(2011) 1395 final
http://ec.europa.eu/energy/nuclear/safety/doc/com_2011_0784_technical_summary.pdf
- [6] Targeted Safety Re-assessment Report, PA Zrt. October 31, 2011.
<http://atomeromu.hu/download/7799/CBFJ.pdf>
- [7] Post-Fukushima “STRESS TESTS” of European Nuclear Power Plants – Contents and Format of National Reports, HLG_p(2011-16)_85,
[http://www.ensreg.eu/sites/default/files/HLG_p\(2011-16\)_85%20Post%20Fukushima%20Stress%20Tests%20-%20Contents%20and%20Format%20of%20National%20Reports.pdf](http://www.ensreg.eu/sites/default/files/HLG_p(2011-16)_85%20Post%20Fukushima%20Stress%20Tests%20-%20Contents%20and%20Format%20of%20National%20Reports.pdf)
- [8] National Report, Republic of Hungary, prepared for the 5th review meeting of the Convention for Nuclear Safety ., 2010.
[http://www.oah.hu/web/v2/portal.nsf/download_en/AE19C1A40FC34FB1C125778C003CE4D4/\\$file/5th_natrep_hungary.pdf](http://www.oah.hu/web/v2/portal.nsf/download_en/AE19C1A40FC34FB1C125778C003CE4D4/$file/5th_natrep_hungary.pdf)

Abbreviations

Abbreviation	Meaning
AEF	Auxiliary Emergency Feedwater
BCC	Backup Command Centre
Bf	Elevation above Baltic Sea level
CDF	Core Damage Frequency
CERES	Fantasy name of the measurement program performed by the MTA KFKI Atomic Energy Research Institute
ECCS	Emergency Core Cooling System
EFTP	Emergency Feedwater Pump
ENSREG	European Nuclear Safety Regulators Group
ERO	Emergency Response Organization
ESW	Essential Service Water
HAEA	Hungarian Atomic Energy Authority
HCLPF	High Confidence Low Probability Failure
IAEA	International Atomic Energy Agency
KTIR	(Hungarian) Government Communication and Information System
MARATHON	Info-communication application of defence administration under the supervision of Ministry of Interior
MCP	Main Coolant Pump
MGV	Main Gate Valve
MSK-64	Medvedev-Sponheuer-Karnik seismic intensity scale
NSC	Nuclear Safety Code
Paks NPP	Paks Nuclear Power Plant Ltd
PCC	Protected Command Centre
PGA	Peak Ground Acceleration
PHARE	Poland and Hungary: Assistance for Restructuring their Economies
PLC	Programmable logic controller
PSA	Probabilistic Safety Assessment
PSHA	Probabilistic Seismic Hazard Analysis
PSR	Periodic Safety Review
SAM	Severe Accident Management
SAMG	Severe Accident Management Guideline
SG	Steam Generator
SSE	Safe Shutdown Earthquake (= maximum design earthquake, at which nuclear safety of the unit is guaranteed)

Abbreviation	Meaning
TELEPERM-XS	Trade mark of Siemens Gmbh – nuclear power plant safety digital system
TSC	Technical Support Centre
TSR	Targeted Safety Re-assessment
UPS	Uninterrupted Power Supply
US NRC	United States Nuclear Regulatory Commission
VVER	: Vodo-Vodyanoi Energetichesky Reactor (= water moderated, water cooled energetic reactor)
WENRA	Western European Nuclear Safety Regulators Association